

PSTricks

pst-circ

A PSTricks package for drawing electric circuits; v.1.51

February 21, 2009

Documentation by
Herbert Voß

Package author(s):
Christoph Jorssen
Herbert Voß

Contents

1 The basic system	4
1.1 Parameters	4
1.2 Macros	4
1.3 Parameters	9
1.4 Special objects	20
1.5 Examples	21
2 Microwave symbols	30
2.1 New monopole components	30
2.2 New monopole macro-components	31
2.3 New dipole macro-components	32
2.4 New tripole macro-components	35
2.5 New quadripole macro-components	36
2.6 Examples	37
3 Flip Flops – logical elements	39
3.1 The Options	39
3.2 Basic Logical Circuits	39
3.3 RS Flip Flop	44
3.4 D Flip Flop	45
3.5 JK Flip Flop	45
3.6 Other Options	46
3.7 The Node Names	46
3.8 Examples	47
4 Adding new components	48
5 List of all optional arguments for pst-circ	51
References	53

The package `pst-circ` is a collection of graphical elements based on `PStricks` that can be used to facilitate display of electronic circuit elements. For example, an equivalent circuit of a voltage source, its source impedance, and a connected load can easily be constructed along with arrows indicating current flow and potential differences. The emphasis is upon the circuit elements and the details of the exact placement are hidden as much as possible so the author can focus on the circuitry without the distraction of sorting out the underlying vector graphics.

`pst-circ` loads by default the following packages: `pst-node`, `multido`, `pst-xkey`, and, of course `pstricks`. All should be already part of your local $\text{T}_{\text{E}}\text{X}$ installation. If not, or in case of having older versions, go to <http://www.CTAN.org/> and load the newest version.

Thanks to:

Rafal Bartczuk, François Boone, Jean-Côme Charpentier, Patrick Drechsler, Amit Finkler, Henning Heinze, Manuel Luque, Ted Pavlic, Alan Ristow, Douglas Waud, and Richard Weissnar.

1 The basic system

1.1 Parameters

There are specific parameters defined to change easily the behaviour of the pst-circ objects you are drawing. You'll find a list in Section 5 on p. 51.

1.2 Macros

Dipole macros

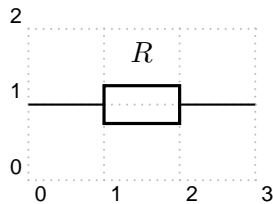

```

1 \begin{pspicture}[showgrid=true](3,2)
2   \nnode(0,1){A}
3   \nnode(3,1){B}
4   \resistor(A)(B){$R$}
5 \end{pspicture}

```

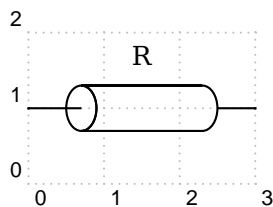

```

1 \begin{pspicture}[showgrid=true](3,2)
2   \nnode(0,1){A}
3   \nnode(3,1){B}
4   \RFLine(A)(B){R}
5 \end{pspicture}

```

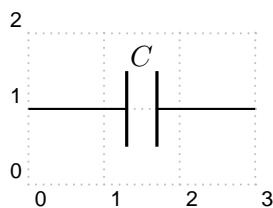

```

1 \begin{pspicture}[showgrid=true](3,2)
2   \nnode(0,1){A}
3   \nnode(3,1){B}
4   \capacitor(A)(B){$C$}
5 \end{pspicture}

```

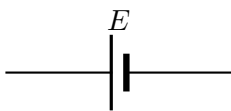

```

1 \begin{pspicture}(3,2)
2   \nnode(0,1){A}
3   \nnode(3,1){B}
4   \battery(A)(B){$E$}
5 \end{pspicture}

```

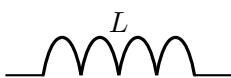

```

1 \begin{pspicture}(3,2)
2   \nnode(0,1){A}
3   \nnode(3,1){B}
4   \coil(A)(B){$L$}
5 \end{pspicture}

```

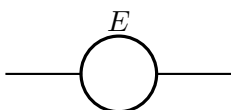

```

1 \begin{pspicture}(3,2)
2   \nnode(0,1){A}
3   \nnode(3,1){B}
4   \Ucc(A)(B){$E$}
5 \end{pspicture}

```

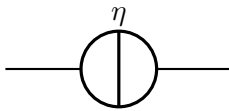

```

1 \begin{pspicture}(3,2)
2 \nnode(0,1){A}
3 \nnode(3,1){B}
4 \Icc(A)(B){\eta}
5 \end{pspicture}

```

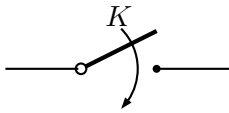

```

1 \begin{pspicture}(3,2)
2 \nnode(0,1){A}
3 \nnode(3,1){B}
4 \switch(A)(B){K}
5 \end{pspicture}

```

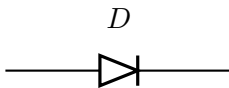

```

1 \begin{pspicture}(3,2)
2 \nnode(0,1){A}
3 \nnode(3,1){B}
4 \diode(A)(B){D}
5 \end{pspicture}

```

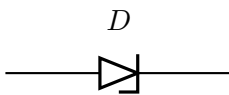

```

1 \begin{pspicture}(3,2)
2 \nnode(0,1){A}
3 \nnode(3,1){B}
4 \Zener(A)(B){D}
5 \end{pspicture}

```

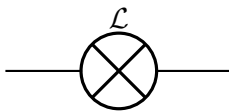

```

1 \begin{pspicture}(3,2)
2 \nnode(0,1){A}
3 \nnode(3,1){B}
4 \lamp(A)(B){\mathcal L}
5 \end{pspicture}

```

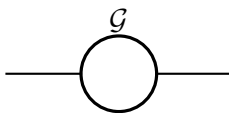

```

1 \begin{pspicture}(3,2)
2 \nnode(0,1){A}
3 \nnode(3,1){B}
4 \circledipole(A)(B){\mathcal G}
5 \end{pspicture}

```

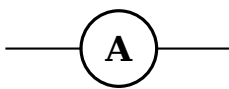

```

1 \begin{pspicture}(3,2)
2 \nnode(0,1){A}
3 \nnode(3,1){B}
4 \circledipole[labeloffset=0](A)(B){\Large\textbf{A}}
5 \end{pspicture}

```

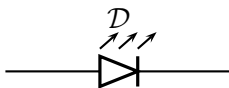

```

1 \begin{pspicture}(3,2)
2 \nnode(0,1){A}
3 \nnode(3,1){B}
4 \LED(A)(B){\mathcal D}
5 \end{pspicture}

```

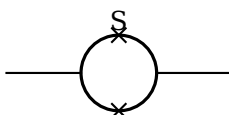

```

1 \begin{pspicture}(3,2)
2 \nnode(0,1){A}
3 \nnode(3,1){B}
4 \SQUID(A)(B){S}
5 \end{pspicture}

```

Tripole macros

Obviously, tripoles are not node connections. So `pst-circ` tries its best to adjust the position of the tripole regarding the three nodes. Internally, the connections are done by the `\ncangle` `pst-node` macro. However, the auto-positioning and the auto-connections are not always well chosen, so don't try to use tripole macros in strange situations!

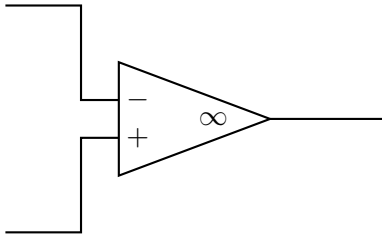

```

1 \begin{pspicture}(5,3)
2 \nnode(0,0){A}
3 \nnode(0,3){B}
4 \nnode(5,1.5){C}
5 \OA(B)(A)(C)
6 \end{pspicture}

```

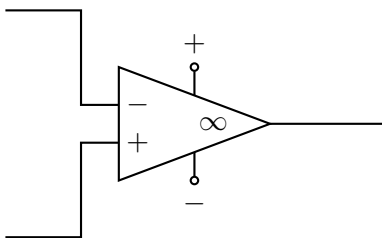

```

1 \begin{pspicture}(5,3)
2 \nnode(0,0){A}
3 \nnode(0,3){B}
4 \nnode(5,1.5){C}
5 \OA[0Apower=true](B)(A)(C)
6 \end{pspicture}

```

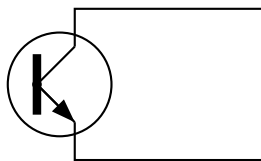

```

1 \begin{pspicture}(3,4)
2 \nnode(0,2){A}\nnode(3,1){B}
3 \nnode(3,3){C}
4 \transistor(A)(B)(C)
5 \end{pspicture}

```

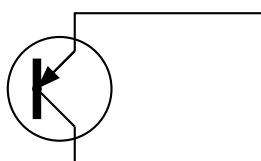

```

1 \begin{pspicture}(3,4)
2 \nnode(0,2){A}\nnode(3,1){B}
3 \nnode(3,3){C}
4 \transistor[transistortype=PNP](A)(B)(C)
5 \end{pspicture}

```

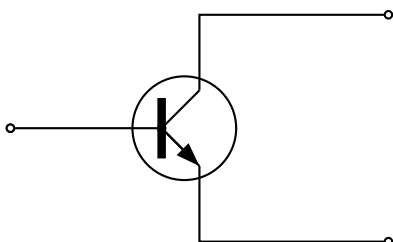

```

1 \begin{pspicture}(5,3)
2 \nnode(0,1.5){A}
3 \nnode(5,0){B}
4 \nnode(5,3){C}
5 \transistor[basesep=2cm,arrows=o-o](A)(B)(C)
6 \end{pspicture}

```

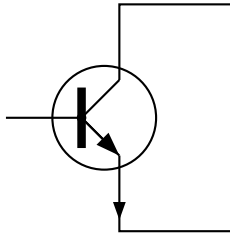

```

1 \begin{pspicture}(3,4)
2 \nnode(0,2){A}\nnode(3,0.5){B}
3 \nnode(3,3.5){C}
4 \transistor[transistoriemitter=true,
5   bassep=1cm](A)(B)(C)
6 \end{pspicture}

```

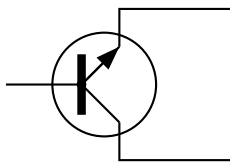

```

1 \begin{pspicture}(3,4)
2 \nnode(0,2){A}\nnode(3,1){B}
3 \nnode(3,3){C}
4 \transistor[transistorinvert,
5   bassep=1cm](A)(B)(C)
6 \end{pspicture}

```

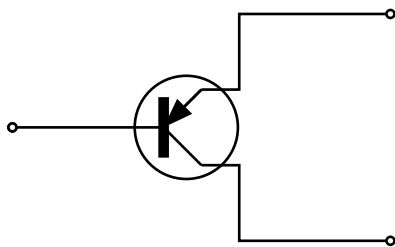

```

1 \begin{pspicture}(5,3)
2 \nnode(0,1.5){A}\psset{linewidth=1pt}
3 \transistor[transistoritype=PNP,bassep=2cm,
4   arrows=o-o](A){Emitter}{Collector}
5 \psline{o-}(5,3)(3,3)(3,3|Collector)(Collector)
6 \psline{o-}(5,0)(3,0)(3,3|Emitter)(Emitter)
7 \psline{o-}(A)([nodesep=2]A)
8 \end{pspicture}

```

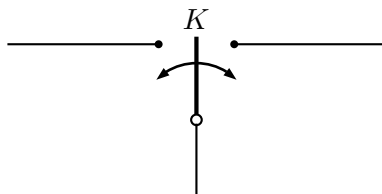

```

1 \begin{pspicture}(5,2)
2 \nnode(0,2){A}
3 \nnode(5,2){B}
4 \nnode(0,0){C}
5 \Tswitch(A)(B)(C){$K$}
6 \end{pspicture}

```

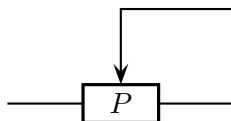

```

1 \begin{pspicture}(3,3)
2 \nnode(0,1){A}
3 \nnode(3,1){B}
4 \nnode(3,2.25){C}
5 \potentiometer[labeloffset=0pt](A)(B)(C){$P$}
6 \end{pspicture}

```

Quadrupole macros

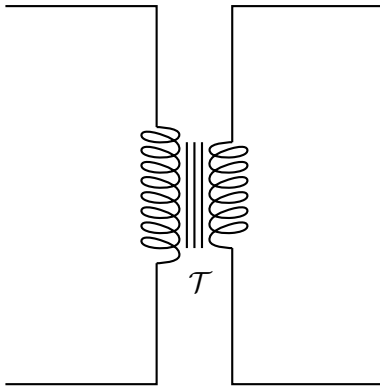

```

1 \begin{pspicture}(5,5)
2   \pnode(0,5){A}
3   \pnode(0,0){B}
4   \pnode(5,5){C}
5   \pnode(5,0){D}
6   \transformer(A)(B)(C)(D){\mathcal T}
7 \end{pspicture}

```

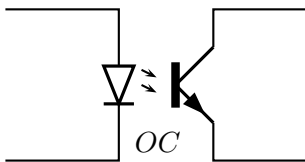

```

1 \begin{pspicture}(5,3)
2   \pnode(0,2.5){A}
3   \pnode(0,0.5){B}
4   \pnode(4,2.5){C}
5   \pnode(4,0.5){D}
6   \optoCoupler(A)(B)(C)(D){$OC$}
7 \end{pspicture}

```

Multidipole

`\multidipole` is a macro that allows multiple dipoles to be drawn between two specified nodes. `\multidipole` takes as many arguments as you want. Note the dot that is after the last dipole.

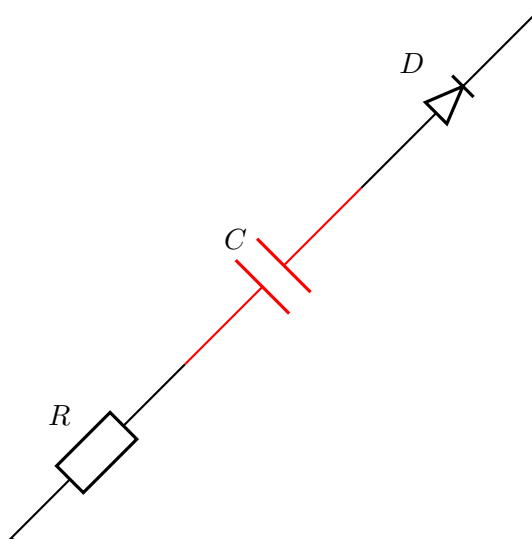

```

1 \begin{pspicture}(7,7)
2   \pnode(0,0){A}
3   \pnode(7,7){B}
4   \multidipole(A)(B)\resistor{$R$}%
5     \capacitor[linecolor=red]{$C$}%
6     \diode{$D$}{}.
7 \end{pspicture}

```

Important: for the time being, `\multidipole` takes optional arguments but does not restore original values. We recommend not using it.

Wire

```

1 \begin{pspicture}(3,2)
2   \node(0,1){A}
3   \node(3,1){B}
4   \wire(A)(B)
5 \end{pspicture}

```

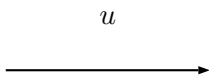
Potential

```

1 \begin{pspicture}(3,2)
2   \node(0,1){A}
3   \node(3,1){B}
4   \tension(A)(B){$u$}
5 \end{pspicture}

```

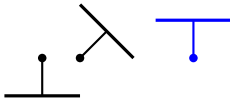
ground

```

1 \begin{pspicture}(3,2)
2   \node(0.5,1){A}
3   \node(1,1){B}
4   \node(2.5,1){C}
5   \ground(A)
6   \ground{135}(B)
7   \ground[linecolor=blue]{180}(C)
8 \end{pspicture}

```

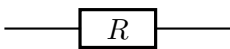
1.3 Parameters**Label parameters**

```

1 \begin{pspicture}(3,1)
2   \node(0,.5){A}
3   \node(3,.5){B}
4   \resistor[labeloffset=0](A)(B){$R$}
5 \end{pspicture}

```

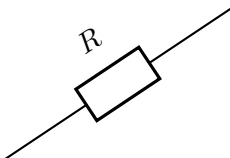

```

1 \begin{pspicture}(3,2)
2   \node(0,0){A}
3   \node(3,2){B}
4   \resistor[labelangle=:U](A)(B){$R$}
5 \end{pspicture}

```

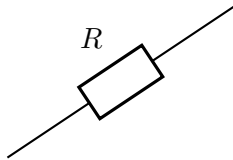

```

1 \begin{pspicture}(3,2)
2   \pnode(0,0){A}
3   \pnode(3,2){B}
4   \resistor[labelangle=0](A)(B){R$}
5 \end{pspicture}

```

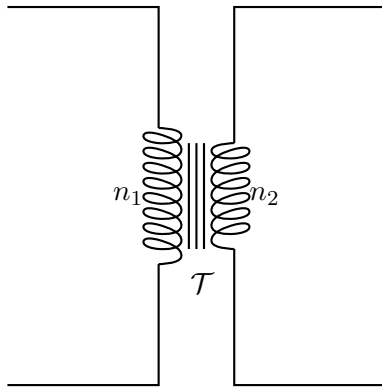

```

1 \begin{pspicture}(5,5)
2   \pnode(0,5){A}
3   \pnode(0,0){B}
4   \pnode(5,5){C}
5   \pnode(5,0){D}
6   \transformer[primarylabel=$n_1$,
7     secondarylabel=$n_2$](A)(B)(C)(D){\mathcal T$}
8 \end{pspicture}

```

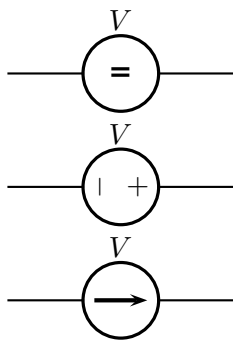

```

1 \begin{pspicture}(3,4.5)
2   \pnode(0,.5){A}
3   \pnode(3,.5){B}
4   \Ucc[labelInside=1](A)(B){V$}
5   \pnode(0,2){A}
6   \pnode(3,2){B}
7   \Ucc[labelInside=2](A)(B){V$}
8   \pnode(0,3.5){A}
9   \pnode(3,3.5){B}
10  \Ucc[labelInside=3](A)(B){V$}
11 \end{pspicture}

```

Current intensity and electrical potential parameters

If the intensity parameter is set to true, an arrow is drawn on the wire connecting one of the nodes to the dipole. If the tension parameter is set to true, an arrow is drawn parallel to the dipole.

The way those arrows are drawn is set by `dipoleconvention` and `directconvention` parameters. `dipoleconvention` can take two values : `generator` or `receptor`. `directconvention` is a boolean.

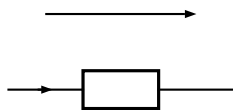

```

1 \begin{pspicture}(3,2)
2   \pnode(0,.5){A}
3   \pnode(3,.5){B}
4   \resistor[intensity,tension](A)(B){}
5 \end{pspicture}

```

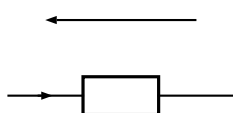

```

1 \begin{pspicture}(3,2)
2   \pnode(0,.5){A}
3   \pnode(3,.5){B}
4   \resistor[intensity,tension,
5     dipoleconvention=generator](A)(B){}
6 \end{pspicture}

```

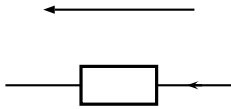

```

1 \begin{pspicture}(3,2)
2   \node(0,.5){A}
3   \node(3,.5){B}
4   \resistor[intensity,tension,
5     directconvention=false](A)(B){}
6 \end{pspicture}

```

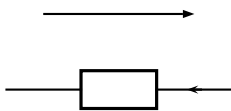

```

1 \begin{pspicture}(3,2)
2   \node(0,.5){A}
3   \node(3,.5){B}
4   \resistor[intensity,tension,
5     dipoleconvention=generator,directconvention=false](A)(B){}
6 \end{pspicture}

```

If intensitylabel is set to a non empty argument, then intensity is automatically set to true. If tensionlabel is set to a non empty argument, then tension is automatically set to true.

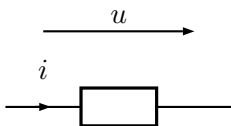

```

1 \begin{pspicture}(3,2)
2   \node(0,.5){A}
3   \node(3,.5){B}
4   \resistor[intensitylabel=$i$,tensionlabel=$u$](A)(B){}
5 \end{pspicture}

```

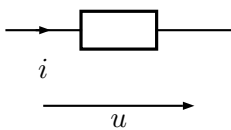

```

1 \begin{pspicture}(3,2)
2   \node(0,1.5){A}
3   \node(3,1.5){B}
4   \resistor[intensitylabel=$i$,intensitylabeloffset=-0.5,
5     tensionlabel=$u$,tensionlabeloffset=-1.2,
6     tensionoffset=-1](A)(B){}
7 \end{pspicture}

```

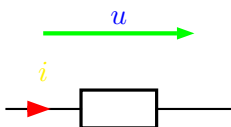

```

1 \begin{pspicture}(3,2)
2   \node(0,.5){A}
3   \node(3,.5){B}
4   \resistor[intensitylabel=$i$,intensitywidth=3\pslinewidth,
5     intensitycolor=red,intensitylabelcolor=yellow,
6     tensionlabel=$u$,tensionwidth=2\pslinewidth,
7     tensioncolor=green,tensionlabelcolor=blue](A)(B){}
8 \end{pspicture}

```

Some specific intensity parameters are available for tripoles and quadrupoles.

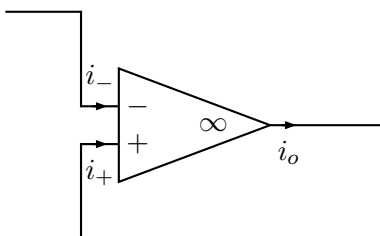

```

1 \begin{pspicture}(5,3)
2   \node(0,0){A}
3   \node(0,3){B}
4   \node(5,1.5){C}
5   \OA[OAipluslabel=$i_+$,
6     OAiminuslabel=$i_-$,
7     OAioutlabel=$i_o$](B)(A)(C)
8 \end{pspicture}

```

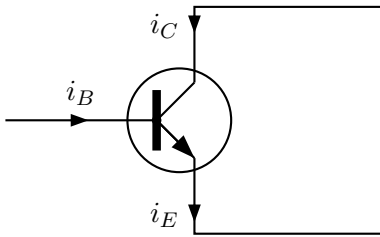

```

1 \begin{pspicture}(5,3)
2   \nnode(0,1.5){A}
3   \nnode(5,0){B}
4   \nnode(5,3){C}
5   \transistor[basesep=2cm,transistoribaselabel=$i_
6     B$,
7     transistoricollectorlabel=$i_C$,
8     transistoriemitterlabel=$i_E$](A)(B)(C)
9 \end{pspicture}

```

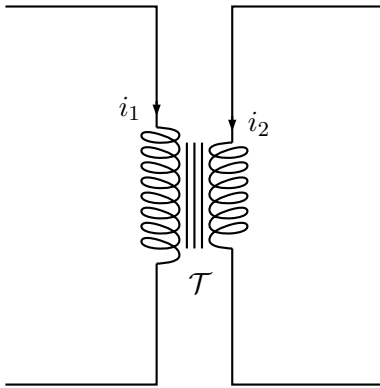

```

1 \begin{pspicture}(5,5)
2   \nnode(0,5){A}
3   \nnode(0,0){B}
4   \nnode(5,5){C}
5   \nnode(5,0){D}
6   \transformer[transformerprimarylabel=$i_1$,
7     transformerisecondarylabel=$i_2$]%(
8     (A)(B)(C)(D){$\mathcal{T}$}
9 \end{pspicture}

```

Parallel parameters

If the parallel parameter is set to true, the dipole is drawn parallel to the line connecting the nodes.

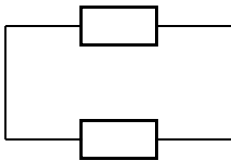

```

1 \begin{pspicture}(3,3)
2   \nnode(0,.5){A}
3   \nnode(3,.5){B}
4   \resistor(A)(B){}
5   \resistor[parallel](A)(B){}
6 \end{pspicture}

```

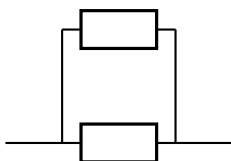

```

1 \begin{pspicture}(3,3)
2   \nnode(0,.5){A}
3   \nnode(3,.5){B}
4   \resistor(A)(B){}
5   \resistor[parallel,parallese=.5](A)(B){}
6 \end{pspicture}

```

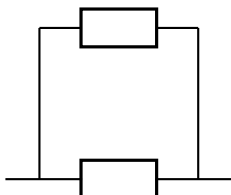

```

1 \begin{pspicture}(3,3)
2   \nnode(0,.5){A}
3   \nnode(3,.5){B}
4   \resistor(A)(B){}
5   \resistor[parallel,parallese=.3,
6     parallelarm=2](A)(B){}
7 \end{pspicture}

```

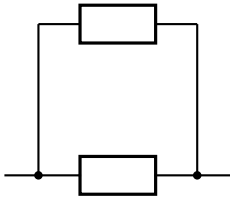

```

1 \begin{pspicture}(3,3)
2 \node(0,.5){A}
3 \node(3,.5){B}
4 \resistor(A)(B){}
5 \resistor[parallel,parallelsep=.3,
6   parallelarm=2,parallelnode](A)(B){}
7 \end{pspicture}

```

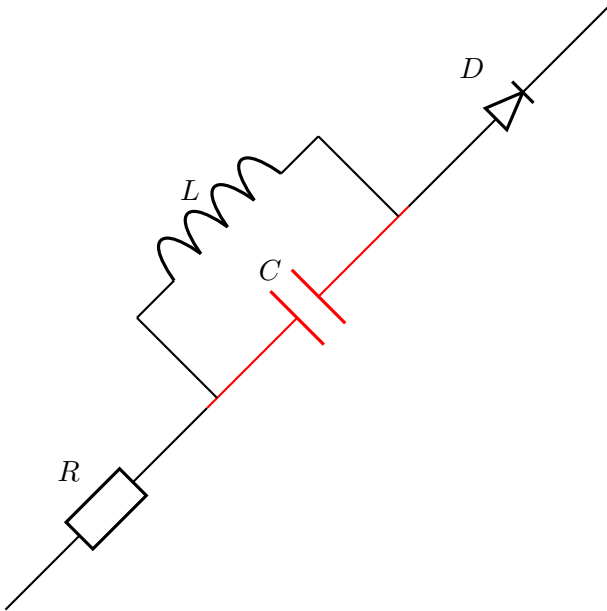

```

1 \begin{pspicture}(8,8)
2 \node(0,0){A}
3 \node(8,8){B}
4 \multidipole(A)(B)\resistor{$R
5   $}%
6 \capacitor[linecolor=red]{$C
7   $}%
8 \coil[parallel,parallelsep
9   =.1]{$L$}%
10 \diode{$D$}.
11 \end{pspicture}

```

Note: When used with `\multidipole`, the `parallel` parameter must not be set for the first dipole.

Wire intersections

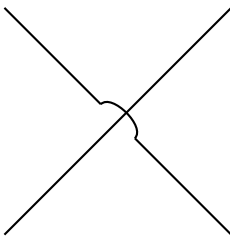

```

1 \begin{pspicture}(3,3)
2 \node(0,0){A}
3 \node(3,3){B}
4 \node(0,3){C}
5 \node(3,0){D}
6 \wire(A)(B)
7 \wire[intersect,intersectA=A,intersectB=B](C)(D)
8 \end{pspicture}

```

Wire intersect parameters work also with `\multidipole`.

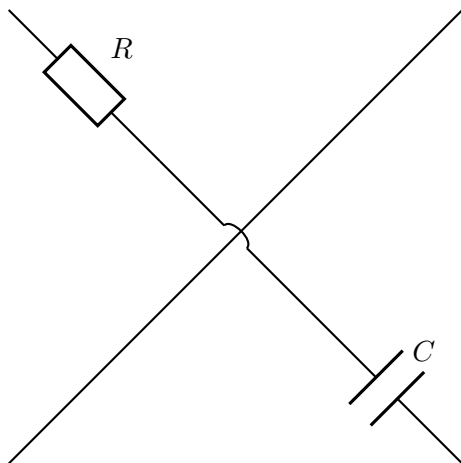

```

1 \begin{pspicture}(7,7)
2   \pnode(0,0){A}
3   \pnode(6,6){B}
4   \pnode(0,6){C}
5   \pnode(6,0){D}
6   \wire(A)(B)
7   \multidipole(C)(D)\resistor{\$R\$}%
8     \wire[intersect,intersectA=A,intersectB=B
9       ]%
10    \capacitor{\$C\$}.
11 \end{pspicture}

```

Dipole style parameters

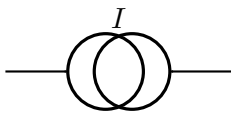

```

1 \begin{pspicture}(3,2)
2   \pnode(0,1){A}
3   \pnode(3,1){B}
4   \Icc[dipolestyle=twoCircles](A)(B){\$I\$}
5 \end{pspicture}

```



```

1 \begin{pspicture}(3,2)
2   \pnode(0,1){A}
3   \pnode(3,1){B}
4   \resistor[dipolestyle=zigzag](A)(B){\$R\$}
5 \end{pspicture}

```

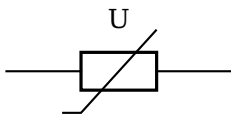

```

1 \begin{pspicture}(3,2)
2   \pnode(0,1){A}
3   \pnode(3,1){B}
4   \resistor[dipolestyle=varistor](A)(B){\$U\$}
5 \end{pspicture}

```

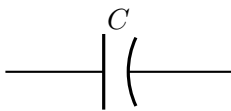

```

1 \begin{pspicture}(3,2)
2   \pnode(0,1){A}
3   \pnode(3,1){B}
4   \capacitor[dipolestyle=chemical](A)(B){\$C\$}
5 \end{pspicture}

```

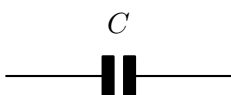

```

1 \begin{pspicture}(3,2)
2   \pnode(0,1){A}
3   \pnode(3,1){B}
4   \capacitor[dipolestyle=elektor](A)(B){\$C\$}
5 \end{pspicture}

```

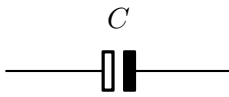

```

1 \begin{pspicture}(3,2)
2   \node(0,1){A}
3   \node(3,1){B}
4   \capacitor[dipolestyle=elektorchemical](A)(B){C$}
5 \end{pspicture}

```

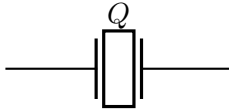

```

1 \begin{pspicture}(3,2)
2   \node(0,1){A}
3   \node(3,1){B}
4   \capacitor[dipolestyle=crystal](A)(B){Q$}
5 \end{pspicture}

```

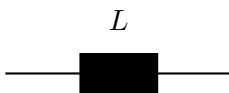

```

1 \begin{pspicture}(3,2)
2   \node(0,1){A}
3   \node(3,1){B}
4   \coil[dipolestyle=rectangle](A)(B){L$}
5 \end{pspicture}

```

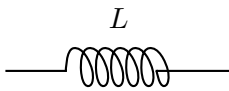

```

1 \begin{pspicture}(3,2)
2   \node(0,1){A}
3   \node(3,1){B}
4   \coil[dipolestyle=curved](A)(B){L$}
5 \end{pspicture}

```

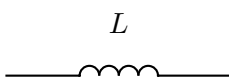

```

1 \begin{pspicture}(3,2)
2   \node(0,1){A}
3   \node(3,1){B}
4   \coil[dipolestyle=elektor](A)(B){L$}
5 \end{pspicture}

```

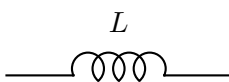

```

1 \begin{pspicture}(3,2)
2   \node(0,1){A}
3   \node(3,1){B}
4   \coil[dipolestyle=elektorcurved](A)(B){L$}
5 \end{pspicture}

```

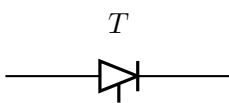

```

1 \begin{pspicture}(3,2)
2   \node(0,1){A}
3   \node(3,1){B}
4   \diode[dipolestyle=thyristor](A)(B){T$}
5 \end{pspicture}

```

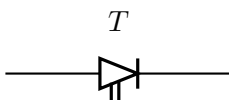

```

1 \begin{pspicture}(3,2)
2   \node(0,1){A}
3   \node(3,1){B}
4   \diode[dipolestyle=GT0](A)(B){T$}
5 \end{pspicture}

```

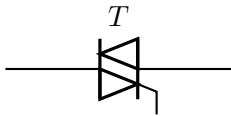

```

1 \begin{pspicture}(3,2)
2   \node(0,1){A}
3   \node(3,1){B}
4   \diode[dipolestyle=triac](A)(B){$T$}
5 \end{pspicture}

```

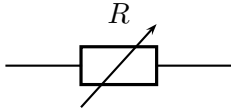

```

1 \begin{pspicture}(3,2)
2   \node(0,1){A}
3   \node(3,1){B}
4   \resistor[variable](A)(B){$R$}
5 \end{pspicture}

```

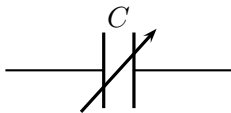

```

1 \begin{pspicture}(3,2)
2   \node(0,1){A}
3   \node(3,1){B}
4   \capacitor[variable](A)(B){$C$}
5 \end{pspicture}

```

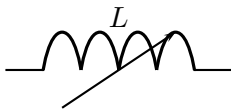

```

1 \begin{pspicture}(3,2)
2   \node(0,1){A}
3   \node(3,1){B}
4   \coil[variable](A)(B){$L$}
5 \end{pspicture}

```

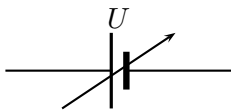

```

1 \begin{pspicture}(3,2)
2   \node(0,1){A}
3   \node(3,1){B}
4   \battery[variable](A)(B){$U$}
5 \end{pspicture}

```

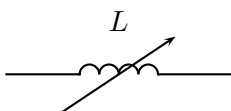

```

1 \begin{pspicture}(3,2)
2   \node(0,1){A}
3   \node(3,1){B}
4   \coil[dipolestyle=elektor,variable](A)(B){$L$}
5 \end{pspicture}

```

In the following example the parameter `dipolestyle` is used for a tripole and quadrupole, because the coils are drawn as rectangles and the resistor as a zigzag.

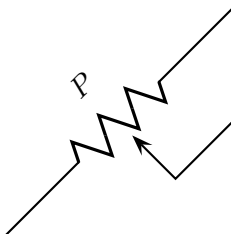

```

1 \begin{pspicture}(3,3)
2   \node(0,0){A}
3   \node(3,3){B}
4   \node(3,1.5){C}
5   \potentiometer[dipolestyle=zigzag,%
6     labelangle=:U](A)(B)(C){$P$}
7 \end{pspicture}

```

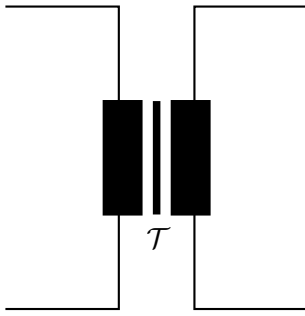

```

1 \begin{pspicture}(4,4)
2   \pnode(0,4){A}
3   \pnode(0,0){B}
4   \pnode(4,4){C}
5   \pnode(4,0){D}
6   \transformer[dipolestyle=rectangle](A)(B)(C)(D){\
7     mathcal T$}
8 \end{pspicture}

```

Tripole style parameters

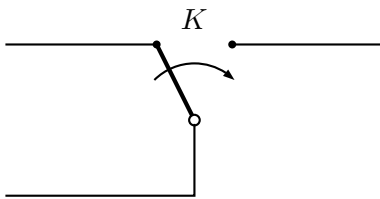

```

1 \begin{pspicture}(5,3)
2   \pnode(0,2){A}
3   \pnode(5,2){B}
4   \pnode(0,0){C}
5   \Tswitch[tripolestyle=left](A)(B)(C){$K$}
6 \end{pspicture}

```

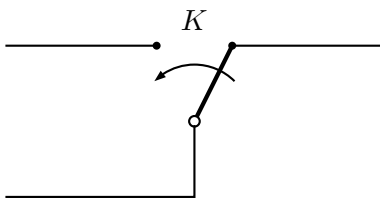

```

1 \begin{pspicture}(5,3)
2   \pnode(0,2){A}
3   \pnode(5,2){B}
4   \pnode(0,0){C}
5   \Tswitch[tripolestyle=right](A)(B)(C){$K$}
6 \end{pspicture}

```

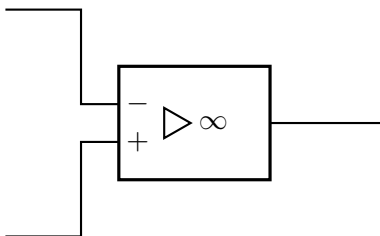

```

1 \begin{pspicture}(5,3)
2   \pnode(0,3){A}
3   \pnode(0,0){B}
4   \pnode(5,1.5){C}
5   \OA[tripolestyle=french](A)(B)(C)
6 \end{pspicture}

```

Potentiometer tripole

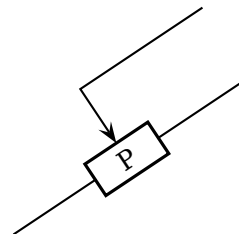
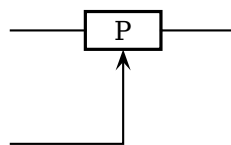
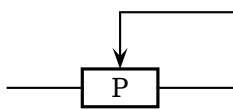

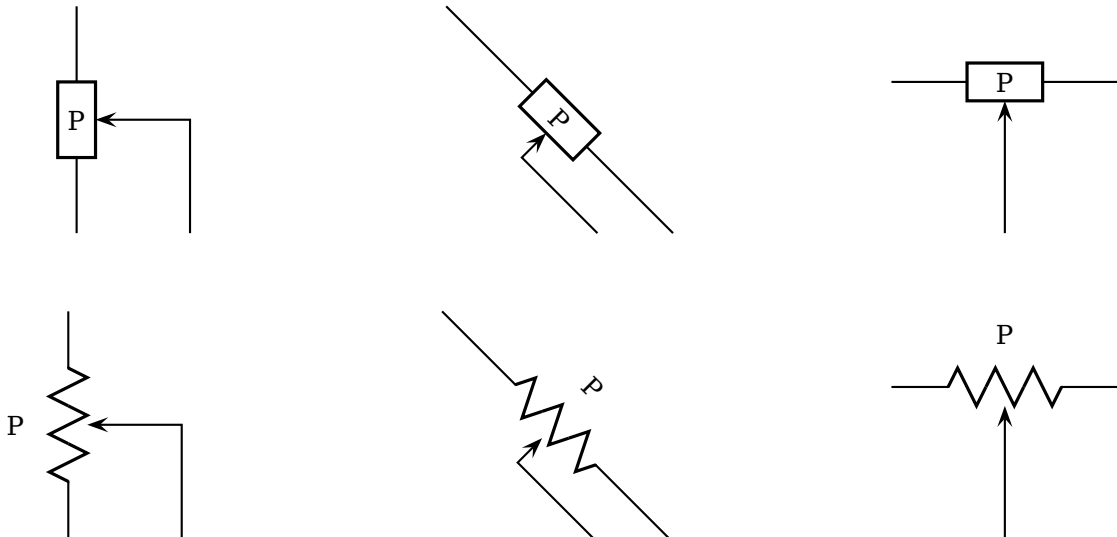

Other Parameters

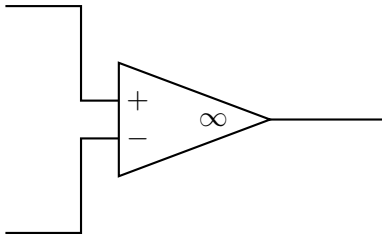

```

1 \begin{pspicture}(5,3)
2 \nnode(0,0){A}
3 \nnode(0,3){B}
4 \nnode(5,1.5){C}
5 \OA[0Ainvert=false](B)(A)(C)
6 \end{pspicture}

```

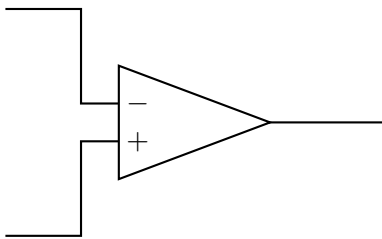

```

1 \begin{pspicture}(5,3)
2 \nnode(0,0){A}
3 \nnode(0,3){B}
4 \nnode(5,1.5){C}
5 \OA[0Aperfect=false](B)(A)(C)
6 \end{pspicture}

```

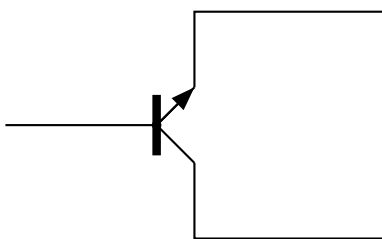

```

1 \begin{pspicture}(5,3)
2 \nnode(0,1.5){A}
3 \nnode(5,0){B}
4 \nnode(5,3){C}
5 \transistor[basesep=2cm,%
6 transistorinvert,transistorcircle=false](A)(B)(
7 C)
8 \end{pspicture}

```

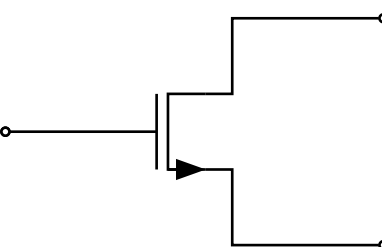

```

1 \begin{pspicture}(5,3)
2 \nnode(0,1.5){A}\psset{linewidth=1pt}
3 \transistor[basesep=2cm,arrows=o-o,
4 transistortype=FET](A){Emitter}{Collector}
5 \psline{o-}(5,3)(3,3)(3,3|Collector)(Collector)
6 \psline{o-}(5,0)(3,0)(3,3|Emitter)(Emitter)
7 \psline{o-}(A)([nodesep=2]A)
8 \end{pspicture}

```

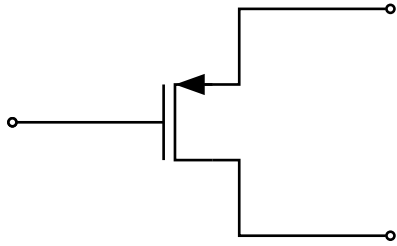

```

1 \begin{pspicture}(5,3)
2 \nnode(0,1.5){A}\psset{linewidth=1pt}
3 \transistor[basesep=2cm,arrows=o-o,
4   transistortype=FET,
5   FETchanneltype=P](A){Emitter}{Collector}
6 \psline{o-}(5,3)(3,3)(3,3|Collector)(Collector)
7 \psline{o-}(5,0)(3,0)(3,3|Emitter)(Emitter)
8 \psline{o-}(A)([nodesep=2]A)
9 \end{pspicture}

```

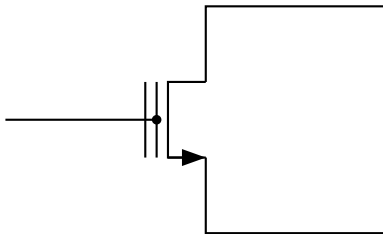

```

1 \begin{pspicture}(5,3)
2 \transistor[basesep=2cm,transistortype=FET,
3   FETmemory=true](0,1.5)(5,0)(5,3)
4 \end{pspicture}

```

1.4 Special objects

\dashpot

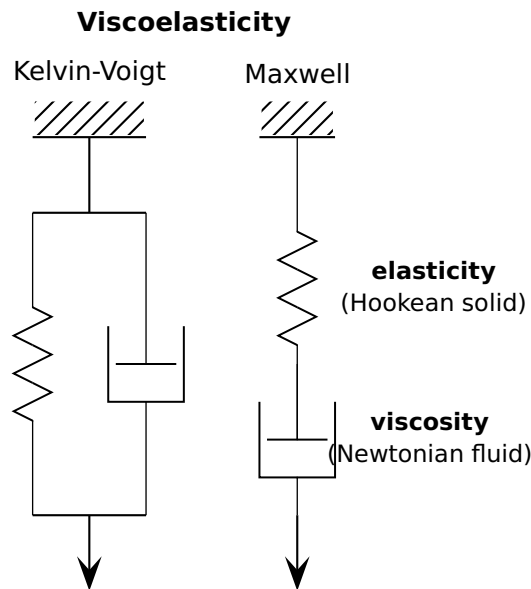

```

1 \newcommand*\pswall[3]{% ll ur lr
2   \psframe[linecolor=white,fillstyle=hlines,hatchcolor=black](#1)(#2)% (ll)(ur)
3   \psline[linecolor=black](#1)(#3)}
4 \begin{pspicture}(0.5,1)(8,10)
5   \rput(3,9.5){\sffamily \textbf{Viscoelasticity}}
6   % Kelvin-Voigt model (spring and dashpot parallel): =====
7   \rput[c](1.75,8.85){\sffamily Kelvin-Voigt}
8   \pswall{1,8}{2.5,8.5}{2.5,8}% top
9   \psline(1.75,8)(1.75,7)% top vertical line
10  % node definitions:
11  \pnode(1,7){ul1}\pnode(2.5,7){ur1} \pnode(1,3){ll1}\pnode(2.5,3){lr1}%
12  \psline(ul1)(ur1)% top line
13  \psline(ll1)(lr1)% bottom line
14  \resistor[dipolestyle=zigzag,linewidth=0.5pt](ul1)(ll1){}% spring
15  \dashpot[linewidth=0.5pt](ur1)(lr1){}% dashpot
16  \psline[arrowscale=3]{->}(1.75,3)(1.75,2)% force
17  % Maxwell model (spring and dashpot serial): =====
18  \rput[c](4.5,8.85){\sffamily Maxwell}
19  \pswall{4,8}{5,8.5}{5,8}% top
20  \pnode(4.5,8){t}\pnode(4.5,4){b}% node definitions
21  \resistor[dipolestyle=zigzag,linewidth=0.5pt,labeloffset=1.8](t)(b)% spring
22  {\sffamily\small\begin{tabular}{c}\textbf{elasticity}\(\(\text{Hookean solid})\end{tabular}
23  }% end spring
24  \dashpot[linewidth=0.5pt,labeloffset=1.8](4.5,5)(4.5,3)% dashpot
25  {\sffamily\small\begin{tabular}{c}\textbf{viscosity}\(\(\text{Newtonian fluid})\end{tabular}
26  }% end dashpot
27  \psline[arrowscale=3]{->}(4.5,3)(4.5,2)% force
28 \end{pspicture}

```

1.5 Examples

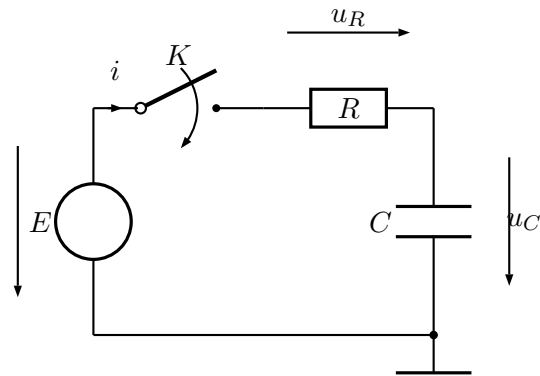

```

1 \begin{pspicture}(-1.5,-1)(6,5)
2 % [subgriddiv=1,griddots=10]
3 % Node definitions
4 \pnode(0,0){A}
5 \pnode(0,3){B}
6 \pnode(4.5,3){C}
7 \pnode(4.5,0){D}
8 % Dipole node connection
9 \Ucc[tension,dipoleconvention=generator](A)(B){$E$}
10 \multidipole(B)(C)%
11 \switch[intensitylabel=$i$]{$K$}%
12 \resistor[labeloffset=0,tensionlabel=$u_R$]{$R$}.
13 \capacitor[tensionlabel={$u_C$},
14 tensionlabeloffset=-1.2,tensionoffset=-1,
15 directconvention=false](D)(C){$C$}
16 % Wire to complete circuit
17 \wire(A)(D)
18 % Ground
19 \ground(D)
20 \end{pspicture}

```

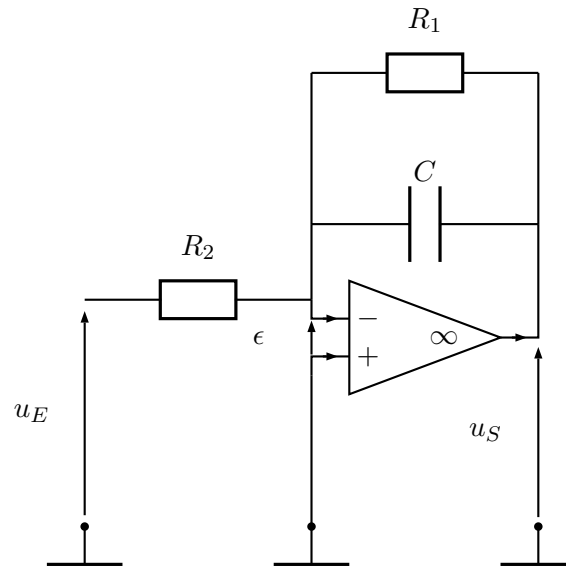

```

1 \begin{pspicture}(-0.5,0)(7,8)
2 % [subgriddiv=1,griddots=10]
3 % Node definitions
4 \node(0.5,1){A}
5 \node(3.5,1){B}
6 \node(6.5,1){C}
7 \node(0.5,4){D}
8 \node(3.5,4){Minus}
9 \node(3.5,3){Plus}
10 \node(6.5,5){S}
11 \node(3.5,5){E}
12 % Dipole node connections
13 \resistor(D)(Minus){$R_2$}
14 \capacitor(E)(S){$C$}
15 \resistor[parallel,parallelarm=2](E)(S){$R_1$}
16 \OA[intensity](Minus)(Plus)(S)
17 % Wires
18 \wire(Minus)(E)
19 \wire(Plus)(B)
20 % Tensions
21 \tension(A)(D){$u_E$}
22 \makeatletter % (special tricks see below)
23 \tension(C)(S@@){$u_S$}
24 \tension[linecolor=blue](Plus@@)(Minus@@){$\epsilon$}
25 \makeatother
26 % Grounds
27 \ground(A)
28 \ground(B)
29 \ground(C)
30 \end{pspicture}

```

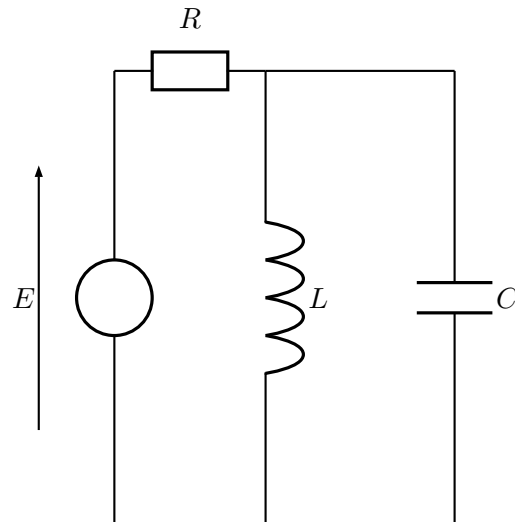

```

1 \begin{pspicture}(-1,0)(7,8)
2 % [subgriddiv=1,griddots=10]
3 % Node definitions
4 \pnode(1,1){A}
5 \pnode(1,7){B}
6 \pnode(3,1){C}
7 \pnode(3,7){D}
8 % Dipole node connections
9 \Ucc[tensionlabel=$E$](A)(B){}
10 \resistor(B)(D){$R$}
11 \coil(D)(C){$L$}
12 \capacitor[parallel,parallellarm=2.5](D)(C){$C$}
13 % Wire
14 \wire(A)(C)
15 \end{pspicture}

```

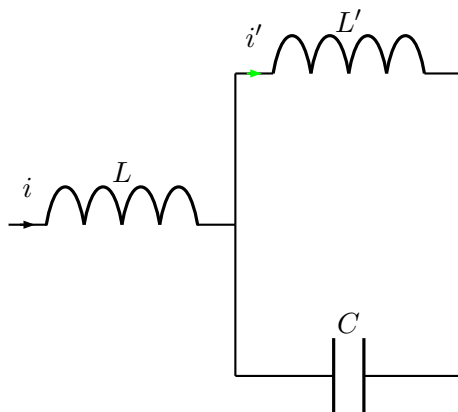

```

1 \begin{pspicture}(-0.25,-0.25)
2 (6,6)
3 % [subgriddiv=1,griddots=10]
4 % Node definitions
5 \pnode(0,3){A}
6 \pnode(3,3){B}
7 \pnode(6,3){C}
8 % Dipole node connections
9 \coil[intensitylabel=$i$](A)(B)
10 \coil[intensitylabel=$i'$,
11 intensitycolor=green,%
12 parallel,parallellarm=2](B)(C)
13 \capacitor[parallel,parallellarm
14 =-2](B)(C){$C$}
15 \end{pspicture}

```

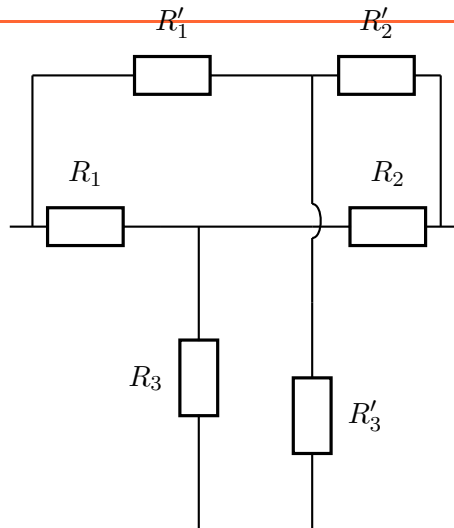

```

1 \begin{pspicture}(6,6)
2 % [subgriddiv=1,griddots=10]
3 % Node definitions
4 \pnode(0,0){A}\pnode(6,0){B}
5 \pnode(0.3,4){Cprime}\pnode(5.7,4){Dprime}
6 \pnode(2.5,4){Gprime}\pnode(2.5,0){Hprime}
7 \pnode(0,4){C}\pnode(6,4){D}
8 \pnode(0.3,6){E}\pnode(5.7,6){F}
9 \pnode(4,6){G}\pnode(4,0){H}
10 \multidipole(G)(H)%
11 \wire[intersect,
12 intersectA=C,intersectB=D]
13 \resistor{$R'_3$}.
14 \resistor(E)(G){$R'_1$}
15 \resistor(G)(F){$R'_2$}
16 \multidipole(C)(D)\resistor{$R_1$}%
17 \wire\resistor{$R_2$}.
18 \wire(A)(B)\wire(Cprime)(E)
19 \wire(Dprime)(F)
20 \resistor(Hprime)(Gprime){$R_3$}
21 \end{pspicture}

```

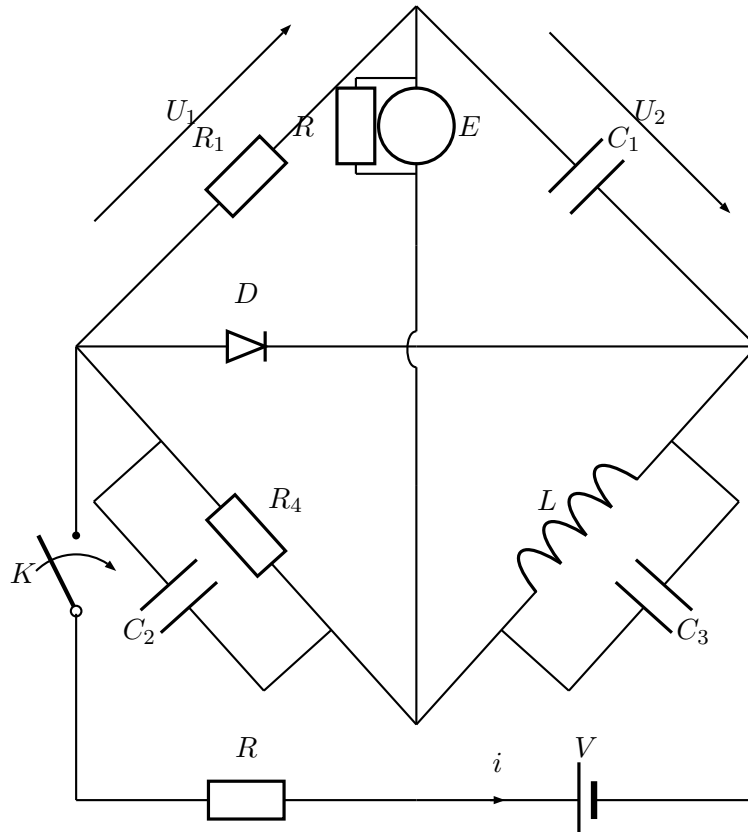

```

1 \begin{pspicture}(0,-0.25)(9,11)
2 % Node definitions
3 \pnode(0,0){A}\pnode(9,0){B}\pnode(0,6){C}\pnode(9,6){D}\pnode(4.5,1){E}\pnode
4 (4.5,10.5){F}
5 %
6 \switch(A)(C){K$}
7 \multidipole(A)(B)\resistor{$R$}\battery[intensitylabel=$i$]{$V$}.
8 \wire(B)(D)
9 \multidipole(C)(D)\diode{$D$}\wire.
10 \resistor[tensionlabel=$U_1$](C)(F){$R_1$} \resistor(C)(E){$R_4$}
11 \capacitor[parallel,parallellarm=1.2,parallelsep=1.5](C)(E){$C_2$}
12 \coil(E)(D){$L$}
13 \capacitor[parallel,parallellarm=1.2,parallelsep=1.5](E)(D){$C_3$}
14 \capacitor[tensionlabel=$U_2$](F)(D){$C_1$}
15 \multidipole(E)(F)\wire\wire[intersect,intersectA=C,intersectB=D]%
16 \circledipole[labeloffset=-0.7]{$E$}%
17 \resistor[parallel,parallelsep=.6,parallellarm=.8]{$R$}.
18 \end{pspicture}

```

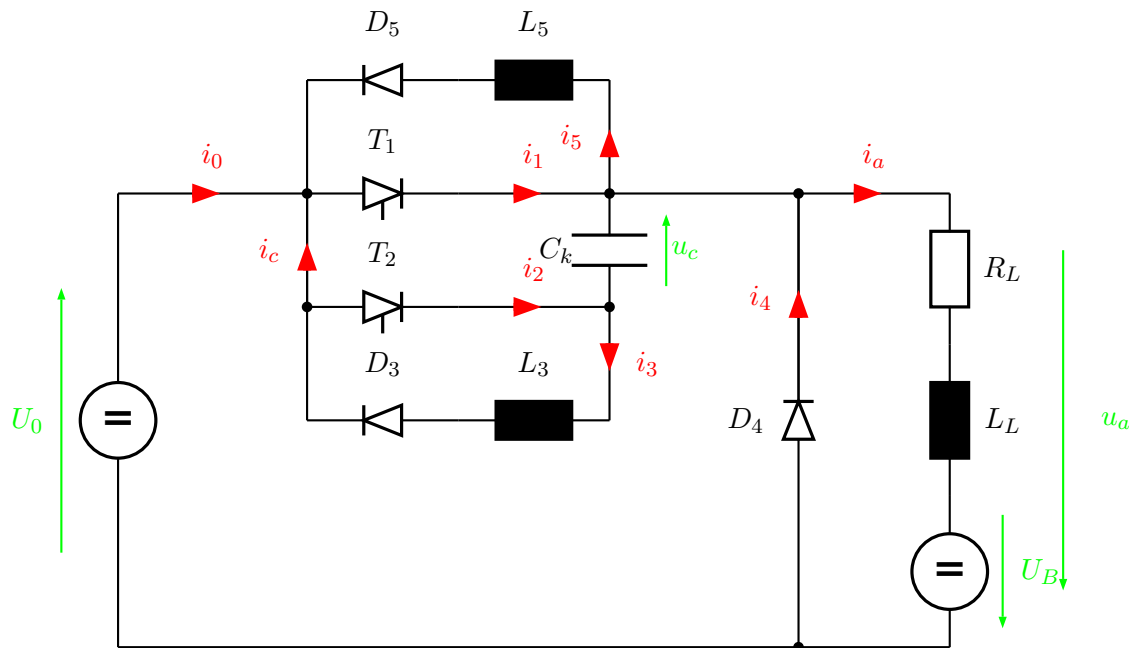

```

1 \begin{pspicture}(0,-0.2)(13,8)
2 \psset{intensitycolor=red,intensitylabelcolor=red,tensioncolor=green,
3 tensionlabelcolor=green,intensitywidth=3pt}
4 \circledipole[tension,tensionlabel=$U_0$,
5 tensionoffset=0.75,labeloffset=0](0,0)(0,6){\LARGE\textbf{=}}
6 \wire[intensity,intensitylabel=$i_0$](0,6)(2.5,6)
7 \diode[dipolestyle=thyristor](2.5,6)(4.5,6){$T_1$}
8 \wire[intensity,intensitylabel=$i_1$](4.5,6)(6.5,6)
9 \multidipole(6.5,7.5)(2.5,7.5)%
10 \coil[dipolestyle=rectangle,labeloffset=-0.75]{$L_5$}%
11 \diode[labeloffset=-0.75]{$D_5$}.
12 \wire[intensity,intensitylabel=$i_5$](6.5,6)(6.5,7.5)
13 \wire(2.5,7.5)(2.5,3)
14 \wire[intensity,intensitylabel=$i_c$](2.5,4.5)(2.5,6)
15 \qdisk(2.5,6){2pt}\qdisk(6.5,6){2pt}
16 \diode[dipolestyle=thyristor](2.5,4.5)(4.5,4.5){$T_2$}
17 \wire[intensity,intensitylabel=$i_2$](4.5,4.5)(6.5,4.5)
18 \capacitor[tension,tensionlabel=$u_c$,tensionoffset=-0.75,
19 tensionlabeloffset=-1](6.5,4.5)(6.5,6){$C_k$}
20 \qdisk(2.5,4.5){2pt}\qdisk(6.5,4.5){2pt}
21 \wire[intensity,intensitylabel=$i_3$](6.5,4.5)(6.5,3)
22 \multidipole(6.5,3)(2.5,3)%
23 \coil[dipolestyle=rectangle,labeloffset=-0.75]{$L_3$}%
24 \diode[labeloffset=-0.75]{$D_3$}.
25 \wire(6.5,6)(9,6)\qdisk(9,6){2pt}
26 \diode(9,0)(9,6){$D_4$}
27 \wire[intensity,intensitylabel=$i_4$](9,3.25)(9,6)
28 \wire[intensity,intensitylabel=$i_a$](9,6)(11,6)
29 \multidipole(11,6)(11,0)%
30 \resistor{$R_L$}
31 \coil[dipolestyle=rectangle]{$L_L$}
32 \circledipole[labeloffset=0,tension,tensionoffset=0.7,tensionlabel=$U_B$]{\LARGE\textbf{=}}.
33 \wire(0,0)(11,0)\qdisk(9,0){2pt}
34 \pnode(12.5,5.5){A}\pnode(12.5,0.5){B}
35 \tension(A)(B){$u_a$}
36 \end{pspicture}

```

The following example was written by Manuel Luque.

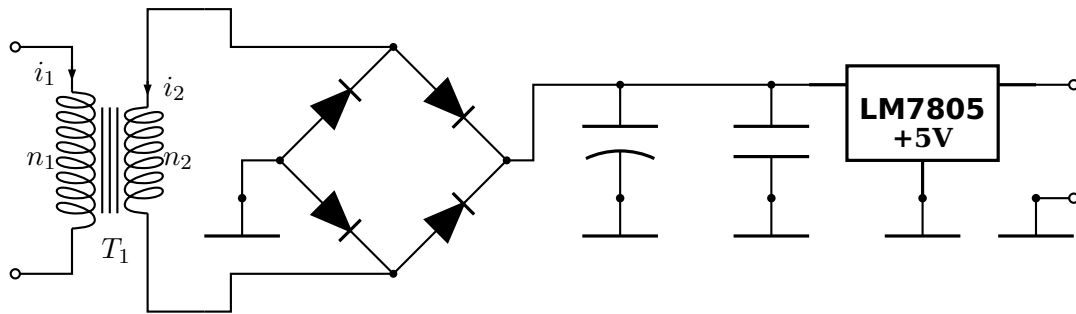

```

1 \begin{pspicture}(0,-0.5)(14,4)
2 % [subgriddiv=1,griddots=10]
3 \pnode(0,0){B}\pnode(0,3){A}
4 \pnode(2.5,3.5){C}\pnode(2.5,-0.5){D}\pnode(5,3){E}\pnode(6.5,1.5){F}
5 \pnode(5,0){G}\pnode(3.5,1.5){H} \pnode(8,2.5){I}\pnode(8,1){J}
6 \pnode(10,2.5){K}\pnode(10,1){L} \pnode(14,2.5){M}\pnode(12,1){N}
7 \pnode(3,1){H'}\pnode(14,2.5){O} \pnode(14,1){P}\pnode(13.5,1){Q}
8 \transformer[transformerprimarylabel=$i_1$,transformersecondarylabel=$i_2$,
9   primarylabel=$n_1$,secondarylabel=$n_2$](A)(B)(C)(D){$T_1$}
10 {\psset{fillstyle=solid,fillcolor=black}
11 \diode(H)(E){}\diode(H)(G){} \diode(E)(F){}\diode(G)(F){}
12 \capacitor[dipolestyle=chemical](I)(J){} \capacitor(K)(L){}
13 \REG(K)(M)(N)%
14   {\shortstack{\textsf{%
15     \textbf{\large LM7805}}\textbf{+5V}}}
16 \ncangle[I]{F}\psline(I)(K) \ncangle[E]{C}\ncangle[G]{D}
17 \ncangle[arm=0]{P}{Q} \ncangle[arm=0]{H}{H'}
18 \ground(H')\ground(J)\ground(L)\ground(N)
19 \ground(Q)\qdisk(I){1.5pt}\qdisk(K){1.5pt}\qdisk(E){1.5pt}
20 \qdisk(G){1.5pt}\qdisk(H){1.5pt}\qdisk(F){1.5pt}
21 \pscircle[fillstyle=solid](A){0.075} \pscircle[fillstyle=solid](B){0.075}
22 \pscircle[fillstyle=solid](P){0.075} \pscircle[fillstyle=solid](O){0.075}
23 \end{pspicture}

```

The following example was written by Lionel Cordesses.

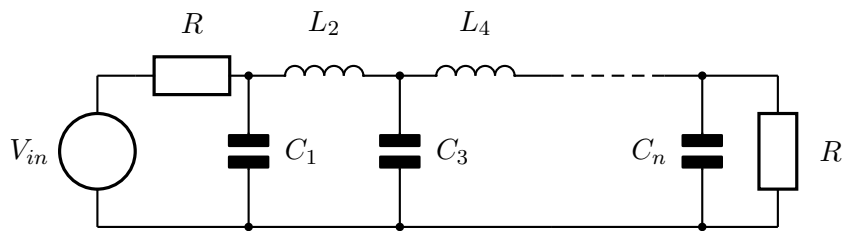

```

1 \begin{pspicture}(11,3)
2 \psset{dipolestyle=elektor}
3 \nnode(1,2){Vin}\nnode(0.5,2){S}\nnode(0.5,0){Sm}
4 \nnode(2.5,2){A}\nnode(4.5,2){B}\nnode(6.5,2){C}
5 \nnode(8,2){Cd}\nnode(8.5,2){D}\nnode(9.5,2){E}
6 \nnode(2.5,0){Am}\nnode(4.5,0){Bm}\nnode(6.5,0){Cm}
7 \nnode(8.5,0){Dm}\nnode(9.5,0){Em}
8 \Ucc[labeloffset=0.9](Sm)(S){$V_{in}$}\resistor(Vin)(A){$R$}
9 \capacitor(A)(Am){$C_1$}\capacitor(B)(Bm){$C_3$}
10 \capacitor[labeloffset=-0.7](D)(Dm){$C_n$}\resistor(E)(Em){$R$}
11 \coil(A)(B){$L_2$}\coil(B)(C){$L_4$}
12 \wire(Am)(Bm)\wire(Bm)(Cm)\wire(Cm)(Dm)\wire(Dm)(Em)\wire(D)(E)
13 \wire(Cd)(D)\psline[linestyle=dashed](C)(Cd)
14 \wire(S)(Vin)\wire(Sm)(Am)
15 \pscircle*(D){2\pslinewidth}\pscircle*(Dm){2\pslinewidth}
16 \pscircle*(A){2\pslinewidth}\pscircle*(Am){2\pslinewidth}
17 \pscircle*(B){2\pslinewidth}\pscircle*(Bm){2\pslinewidth}
18 \end{pspicture}

```

The following example was written by Christian Hoffmann.

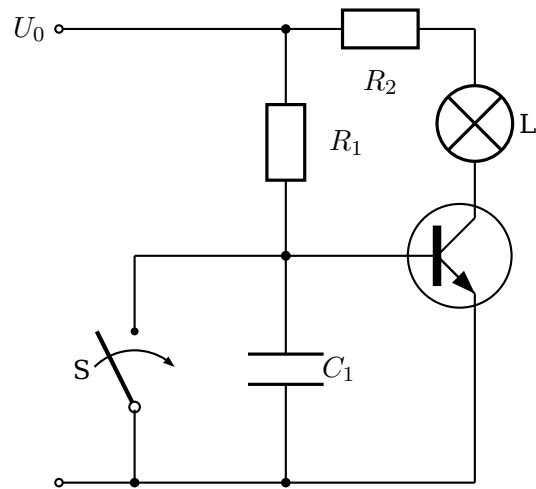

```

1 \SpecialCoor
2 \begin{pspicture}(0,-1)(7,6.5)%
3 \node(0,6){plus}
4 \node(3,3){basis}
5 \node([nodesep=-2] basis){schalter}
6 \node(0,0){masse}
7 \wire[arrows=o-*](plus)(basis|plus)
8 \uput[l](plus){$U_0$}
9 \resistor[labeloffset=.8](basis|plus)(basis){$R_1$}
10 \transistor[basesep=2cm](basis){emitter}{kollektor}
11 \wire[arrows=-*](schalter)(basis)
12 % \wire(basis)([nodesep=2] basis)
13 \wire(TBaseNode)(basis)
14 \switch(schalter|masse)(schalter){S}
15 \lamp(kollektor|plus)(kollektor){L}
16 \resistor(kollektor|plus)(basis|plus){$R_2$}
17 \wire(emitter)(emitter|masse)
18 \wire(emitter|masse)(basis|masse)
19 \capacitor(basis)(basis|masse){$C_1$}
20 \wire[arrows=*-](basis|masse)(schalter|masse)
21 \wire[arrows=-o](schalter|masse)(masse)
22 \end{pspicture}

```

2 Microwave symbols

Since for microwave signal, the direction in which the signal spreads is very important, There are dipoleinput or tripoleinput or quadripoleinput and arrowinput parameters. The value of these parameters are left or right for the first one and true or false for second one.

```

1 \ifPst@inputarrow
2   \ifx\psk@Dinput\pst@Dinput@right
3     \pcline[arrows=-C](#2)(dipole@1)
4     \pcline[arrows=->,arrowinset=0](#3)(dipole@2)
5   \else
6     \pcline[arrows=->,arrowinset=0](#2)(dipole@1)
7     \pcline[arrows=C-](dipole@2)(#3)
8   \fi
9 \else
10  \pcline[arrows=-C](#2)(dipole@1)
11  \pcline[arrows=C-](dipole@2)(#3)
12 \fi
13 \pcline[fillstyle=none,linestyle=none](#2)(#3)

```

The last line is to correct some problems when I use colors (see example2) To add color in components (Monopole, tripole and Quadripole), there is a new argument. `\multidipole` also works:

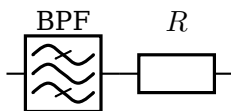

```

1 \begin{pspicture}(4,2)
2   \node(0.5,1){A}
3   \node(3.5,1){B}
4   \multidipole(A)(B)\filter{BPF}%
5   \resistor{$R$}.
6 \end{pspicture}

```

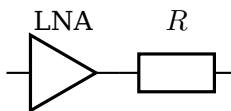

```

1 \begin{pspicture}(4,2)
2   \node(0.5,1){A}
3   \node(3.5,1){B}
4   \multidipole(A)(B)\amplifier{LNA}%
5   \resistor{$R$}.
6 \end{pspicture}

```

2.1 New monopole components

New ground

`groundstyle: ads | old | triangle`

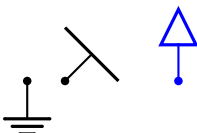

```

1 \begin{pspicture}(3,2)
2   \node(0.5,1){A}
3   \node(1,1){B}
4   \node(2.5,1){C}
5   \newground(A)
6   \newground[groundstyle=old]{135}(B)
7   \newground[linecolor=blue,groundstyle=triangle]{180}(C)
8 \end{pspicture}

```

Antenna

antennastyle: two | three | triangle



```
1 \begin{pspicture}(3,2)
2 \nnode(1,0.5){A}
3 \antenna[antennastyle=three](A)
4 \end{pspicture}
```



```
1 \begin{pspicture}(3,2)
2 \nnode(1,0.5){A}
3 \antenna(A)
4 \end{pspicture}
```



```
1 \begin{pspicture}(3,2)
2 \nnode(1,0.5){A}
3 \antenna[antennastyle=triangle](A)
4 \end{pspicture}
```

2.2 New monopole macro-components

Oscillator

output: top | right | bottom | left

inputarrow: false | true

L0style: - | crystal

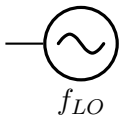

```
1 \begin{pspicture}(3,2)
2 \nnode(1,1){A}
3 \oscillator[output=left,inputarrow=false](A)%
4 {f_{LO}}{}
5 \end{pspicture}
```

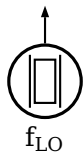

```
1 \begin{pspicture}(3,2)
2 \nnode(1,1){A}
3 \oscillator[output=top,inputarrow=true,L0style=crystal](A)%
4 {f_{\text{trm}{LO}}}{}
```

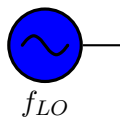

```
1 \begin{pspicture}(3,2)
2 \nnode(1,1){A}
3 \oscillator[output=right,inputarrow=false](A)%
4 {f_{LO}}{fillstyle=solid,fillcolor=blue}
5 \end{pspicture}
```



```
1 \begin{pspicture}(3,2)
2 \nnode(1,1){A}
3 \oscillator[output=bottom,inputarrow=false](A)%
4 {f_{LO}}{}
5 \end{pspicture}
```

2.3 New dipole macro-components

Filters

dipolestyle: bandpass | lowpass | highpass

inputarrow: false | true

dipoleinput: left | right

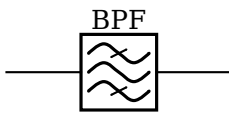

```

1 \begin{pspicture}(3,2)
2   \nnode(0,1){A} \nnode(3,1){B}
3   \filter(A)(B){BPF}
4 \end{pspicture}

```

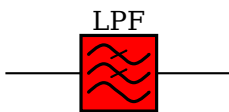

```

1 \begin{pspicture}(3,2)
2   \nnode(0,1){A} \nnode(3,1){B}
3   \filter[dipolestyle=lowpass,fillstyle=solid,%
4     fillcolor=red](A)(B){LPF}
5 \end{pspicture}

```

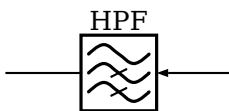

```

1 \begin{pspicture}(3,2)
2   \nnode(0,1){A} \nnode(3,1){B}
3   \filter[dipolestyle=highpass,dipoleinput=right,
4     inputarrow=true](A)(B){HPF}
5 \end{pspicture}

```

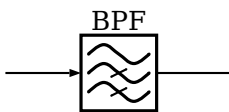

```

1 \begin{pspicture}(3,2)
2   \nnode(0,1){A} \nnode(3,1){B}
3   \filter[dipolestyle=highpass,inputarrow=true](A)(B){BPF}
4 \end{pspicture}

```

Isolator

inputarrow: false | true

dipoleinput: left | right

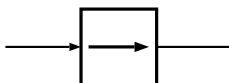

```

1 \begin{pspicture}(3,2)
2   \nnode(0,1){A} \nnode(3,1){B}
3   \isolator[inputarrow=true](A)(B){}
4 \end{pspicture}

```

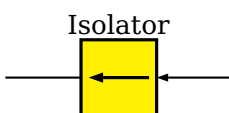

```

1 \begin{pspicture}(3,2)
2   \nnode(0,1){A} \nnode(3,1){B}
3   \isolator[dipoleinput=right,inputarrow=true,
4     fillstyle=solid,fillcolor=yellow](A)(B){Isolator}
5 \end{pspicture}

```

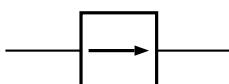

```

1 \begin{pspicture}(3,2)
2   \nnode(0,1){A}\nnode(3,1){B}
3   \isolator[dipoleinput=left](A)(B){}
4 \end{pspicture}

```

Frequency multiplier/divider

dipolestyle: multiplier | divider

value: $N \mid n \in \mathbb{N}$

programmable: false | true

inputarrow: false | true

dipoleinput: left | right

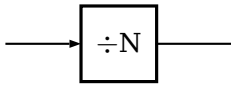

```

1 \begin{pspicture}(3,2)
2   \node(0,1){A}\node(3,1){B}
3   \freqmult[dipolestyle=divider,inputarrow=true](A)(B){}
4 \end{pspicture}

```

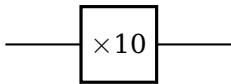

```

1 \begin{pspicture}(3,2)
2   \node(0,1){A}\node(3,1){B}
3   \freqmult[dipolestyle=multiplier,value=10](A)(B){}
4 \end{pspicture}

```

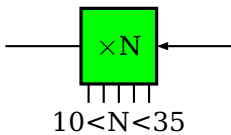

```

1 \begin{pspicture}(3,3)
2   \node(0,1.5){A}\node(3,1.5){B}
3   \freqmult[dipolestyle=multiplier,programmable=true,
4     labeloffset=-1,dipoleinput=right,inputarrow=true,
5     fillstyle=solid,fillcolor=green](A)(B){10<N<35}
6 \end{pspicture}

```

Phase shifter

inputarrow: false | true

dipoleinput: left | right

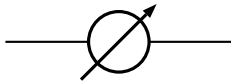

```

1 \begin{pspicture}(3,2)
2   \node(0,1){A1} \node(3,1){A2}
3   \phaseshifter(A1)(A2){}
4 \end{pspicture}

```

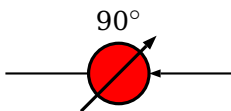

```

1 \begin{pspicture}(3,2)
2   \node(0,1){B1} \node(3,1){B2}
3   \phaseshifter[inputarrow=true,dipoleinput=right,
4     fillstyle=solid,fillcolor=red](B1)(B2){90^\circ}
5 \end{pspicture}

```

VCO

inputarrow: false | true

dipoleinput: left | right



```

1 \begin{pspicture}(3,2)
2   \node(0,1){A1} \node(3,1){A2}
3   \vco[fillstyle=solid,fillcolor=yellow](A1)(A2){}
4 \end{pspicture}

```

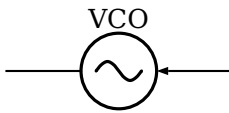

```

1 \begin{pspicture}(3,2)
2   \nnode(0,1){B1} \nnode(3,1){B2}
3   \vco[dipoleinput=right,inputarrow=true](B1)(B2){VCO}
4 \end{pspicture}

```

Amplifier

inputarrow: false| true

dipoleinput: left| right

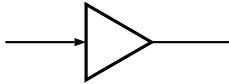

```

1 \begin{pspicture}(3,2)
2   \nnode(0,1){A} \nnode(3,1){B}
3   \amplifier[inputarrow=true](A)(B){}
4 \end{pspicture}

```

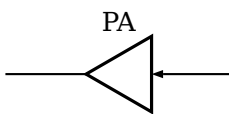

```

1 \begin{pspicture}(3,2)
2   \nnode(0,1){A} \nnode(3,1){B}
3   \amplifier[dipoleinput=right,inputarrow=true](A)(B){PA}
4 \end{pspicture}

```

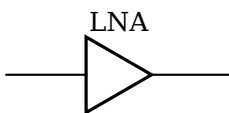

```

1 \begin{pspicture}(3,2)
2   \nnode(0,1){A} \nnode(3,1){B}
3   \amplifier[dipoleinput=left](A)(B){LNA}
4 \end{pspicture}

```

Detector

inputarrow: false| true

dipoleinput: left| right

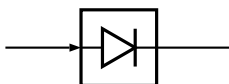

```

1 \begin{pspicture}(3,2)
2   \nnode(0,1){A} \nnode(3,1){B}
3   \detector[inputarrow=true](A)(B){}
4 \end{pspicture}

```

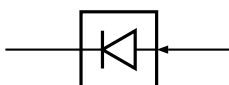

```

1 \begin{pspicture}(3,2)
2   \nnode(0,1){A} \nnode(3,1){B}
3   \detector[dipoleinput=right,inputarrow=true](A)(B){}
4 \end{pspicture}

```

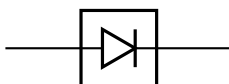

```

1 \begin{pspicture}(3,2)
2   \nnode(0,1){A} \nnode(3,1){B}
3   \detector[dipoleinput=left](A)(B){}
4 \end{pspicture}

```

2.4 New tripole macro-components

Mixer

tripolestyle: bottom | top
tripoleconfig: left | right
inputarrow: false | true

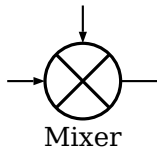

```

1 \begin{pspicture}(3,2)
2 \pnode(0.5,1){A}\pnode(2.5,1){B}\pnode(1.5,2){C}
3 \mixer[tripolestyle=top,inputarrow=true](A)(B)(C)%
4 {Mixer}{}
5 \end{pspicture}

```

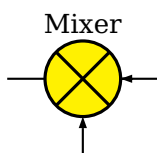

```

1 \begin{pspicture}(3,2)
2 \pnode(0.5,1){A}\pnode(2.5,1){B}\pnode(1.5,0){C}
3 \mixer[inputarrow=true,tripoleinput=right](A)(B)(C)
4 {Mixer}{fillstyle=solid,fillcolor=yellow}
5 \end{pspicture}

```

Circulator

tripolestyle: circulator | isolator
inputarrow: false | true
tripoleinput: left | right

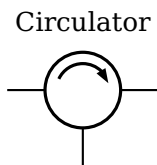

```

1 \begin{pspicture}(3,2)
2 \pnode(0.5,1){A}\pnode(2.5,1){B}\pnode(1.5,0){C}
3 \circulator{0}(A)(B)(C){Circulator}{}
4 \end{pspicture}

```

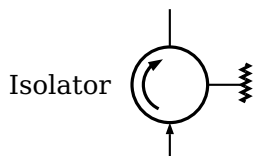

```

1 \begin{pspicture}(3,3)
2 \pnode(1.5,0.5){A}\pnode(1.5,2.5){B}\pnode(0.5,1.5){C}
3 \circulator[tripolestyle=isolator,inputarrow=true]{90}%
4 (A)(B)(C){Isolator}{}
5 \end{pspicture}

```

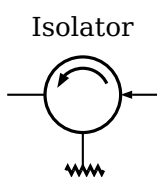

```

1 \begin{pspicture}(3,2)
2 \pnode(0.5,1){A}\pnode(2.5,1){B}\pnode(1.5,0){C}
3 \circulator[tripoleconfig=right,tripolestyle=isolator,
4 inputarrow=true,tripoleinput=right]{0}%
5 (B)(A)(C){Isolator}{}
6 \end{pspicture}

```

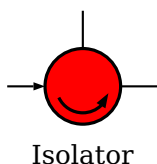

```

1 \begin{pspicture}(3,2)
2 \pnode(0.5,1){A}\pnode(2.5,1){B}\pnode(1.5,2){C}
3 \circulator[tripoleconfig=right,
4 inputarrow=true]{180}(A)(B)(C){Isolator}%
5 {fillstyle=solid,fillcolor=red}
6 \end{pspicture}

```

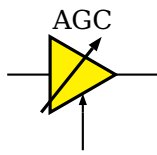
Agc*inputarrow*: false| true*tripoleinput*: left | right

```

1 \begin{pspicture}(3,2)
2   \node(0.5,1){A}\node(2.5,1){B}\node(1.5,0){C}
3   \agc(A)(B)(C){AGC}{fillstyle=solid,fillcolor=yellow}
4 \end{pspicture}

```

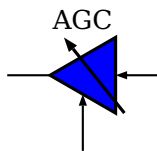

```

1 \begin{pspicture}(3,2)
2   \node(0.5,1){A}\node(2.5,1){B}\node(1.5,0){C}
3   \agc[tripoleinput=right,inputarrow=true](A)(B)(C)%
4     {AGC}{fillstyle=solid,fillcolor=blue}
5 \end{pspicture}

```

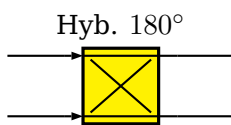
2.5 New quadripole macro-components**Coupler***couplerstyle*: hybrid | directional*inputarrow*: false| true*quadripoleinput*: left | right

```

1 \begin{pspicture}(3,2)
2   \node(0,1.4){A} \node(0,0.6){B}
3   \node(3,1.4){C} \node(3,0.6){D}
4   \coupler[couplerstyle=hybrid,inputarrow=true](A)(B)(C)(D)%
5     {Hyb. $180^\circ\ensuremath{\wedge\circ}}%
6     {fillstyle=solid,fillcolor=yellow}
7 \end{pspicture}

```

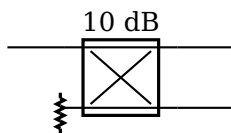

```

1 \begin{pspicture}(3,2)
2   \node(0,1.4){A} \node(0,0.6){B}
3   \node(3,1.4){C} \node(3,0.6){D}
4   \coupler[couplerstyle=directional](A)(B)(C)(D){10~dB}{
5 \end{pspicture}

```

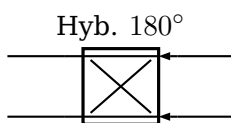

```

1 \begin{pspicture}(3,2)
2   \node(0,1.4){A} \node(0,0.6){B}
3   \node(3,1.4){C} \node(3,0.6){D}
4   \coupler[couplerstyle=hybrid,inputarrow=true,%
5     quadripoleinput=right](A)(B)(C)(D)%
6     {Hyb. $180^\circ\ensuremath{\wedge\circ}}{
7 \end{pspicture}

```

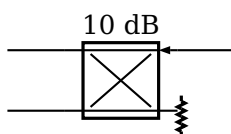

```

1 \begin{pspicture}(3,2)
2   \node(0,1.4){A} \node(0,0.6){B}
3   \node(3,1.4){C} \node(3,0.6){D}
4   \coupler[couplerstyle=directional,quadripoleinput=right,%
5     inputarrow=true](A)(B)(C)(D){10~dB}{
6 \end{pspicture}

```

2.6 Examples

Radiometer block diagram example

From Chang, K., RF and Microwave Wireless Systems, Wiley InterScience, page 319, ISBN 0-471-35199-7

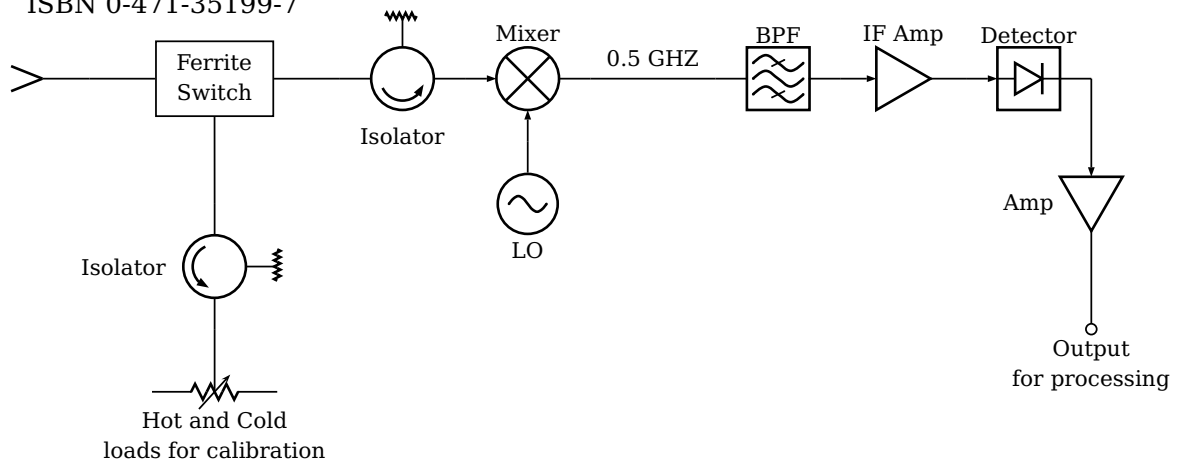

Ku-band Transceiver

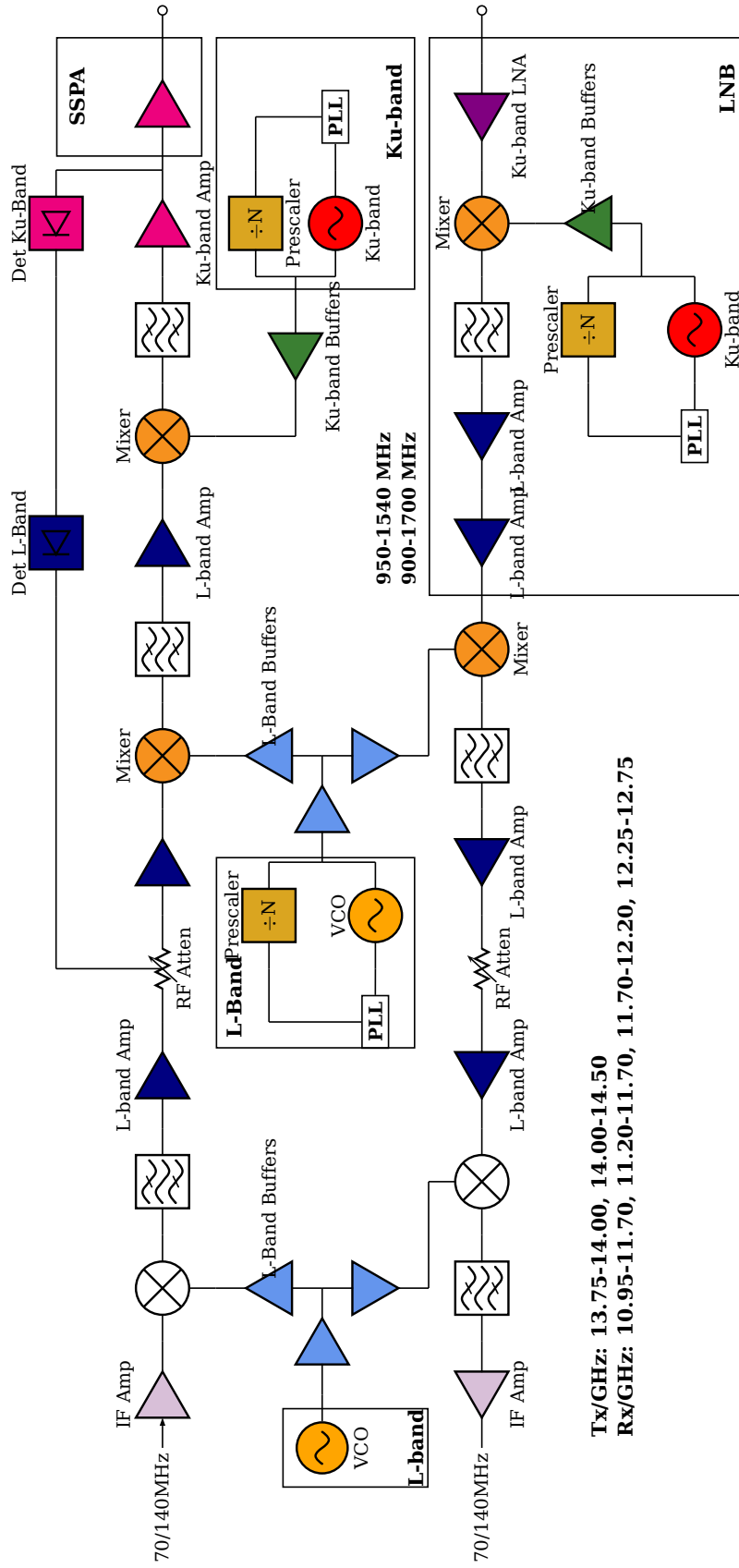

Tx/GHz: 13.75-14.00, 14.00-14.50
Rx/GHz: 10.95-11.70, 11.20-11.70, 11.70-12.20, 12.25-12.75

3 Flip Flops – logical elements

The syntax for all logical base circuits is

```
\logic [Options] (x0, y0) {label}
```

where the options and the origin are optional. If they are missing, then the default options, described in the next section and the default origin (0,0) is used. The origin specifies the lower left corner of the logical circuit.

xLkeywordlogicType

```
1 \logic{Demo}
2 \logic[logicType=and]{Demo}
3 \logic(0,0){Demo}
4 \logic[logicType=and](0,0){Demo}
```

The above four „different“ calls of the `\logic` macro give the same output, because they are equivalent.

3.1 The Options

<i>name</i>	<i>type</i>	<i>default</i>
<code>logicShowNode</code>	boolean	<code>false</code>
<code>logicShowDot</code>	boolean	<code>false</code>
<code>logicNodestyle</code>	command	<code>\footnotesize</code>
<code>logicSymbolstyle</code>	command	<code>\large</code>
<code>logicSymbolpos</code>	value	<code>0.5</code>
<code>logicLabelstyle</code>	command	<code>\small</code>
<code>logicType</code>	string	<code>and</code>
<code>logicChangeLR</code>	boolean	<code>false</code>
<code>logicWidth</code>	length	<code>1.5</code>
<code>logicHeight</code>	length	<code>2.5</code>
<code>logicWireLength</code>	length	<code>0.5</code>
<code>logicNInput</code>	number	<code>2</code>
<code>logicJInput</code>	number	<code>2</code>
<code>logicKInput</code>	number	<code>2</code>

3.2 Basic Logical Circuits

At least the basic objects require a unique label name, otherwise it is not sure, that all nodes will work well. The label may contain any alphanumerical character and most of all symbols. But it is save using only combinations of letters and digits. For example:

```
And0
a0
a123
12
NOT123a
```

A_1 is not a good choice, the underscore may cause some problems.

And

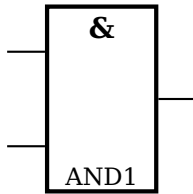

```

1 \begin{pspicture}(-1,0)(3,3)
2 \logic{AND1}
3 \end{pspicture}

```

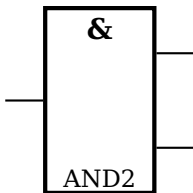

```

1 \begin{pspicture}(-0.5,0)(3,3)
2 \logic[logicChangeLR]{AND2}
3 \end{pspicture}

```

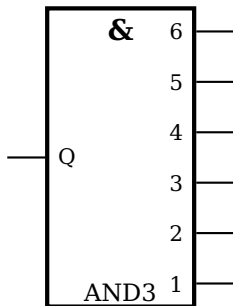

```

1 \begin{pspicture}(-0.5,0)(4,5)
2 \logic[logicShowNode,%
3   logicWidth=2,
4   logicHeight=4,
5   logicNInput=6,
6   logicChangeLR](1,1){AND3}
7 \end{pspicture}

```

NotAnd

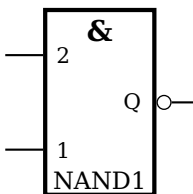

```

1 \begin{pspicture}(-0.5,0)(3,3)
2 \logic[logicType=nand,
3   logicShowNode]{NAND1}
4 \end{pspicture}

```

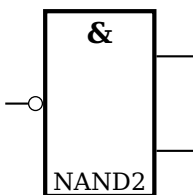

```

1 \begin{pspicture}(-0.5,0)(3,3)
2 \logic[logicType=nand,
3   logicChangeLR]{NAND2}
4 \end{pspicture}

```

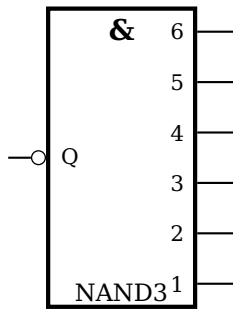

```

1 \begin{pspicture}(4,5)
2 \logic[logicType=nand,
3   logicShowNode,
4   logicWidth=2,
5   logicHeight=4,
6   logicNInput=6,
7   logicChangeLR](1,1){NAND3}
8 \end{pspicture}

```

Or

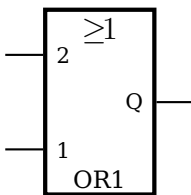

```

1 \begin{pspicture}(-0.5,0)(3,3)
2 \logic[logicType=or,
3   logicShowNode]{OR1}
4 \end{pspicture}

```

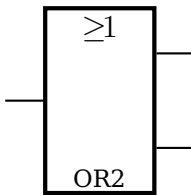

```

1 \begin{pspicture}(-0.5,0)(3,3)
2 \logic[logicType=or,
3   logicChangeLR]{OR2}
4 \end{pspicture}

```

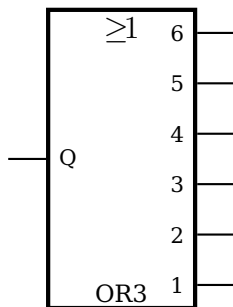

```

1 \begin{pspicture}(4,5)
2 \logic[logicType=or,
3   logicShowNode,
4   logicWidth=2,
5   logicHeight=4,
6   logicNInput=6,
7   logicChangeLR](1,1){OR3}
8 \end{pspicture}

```

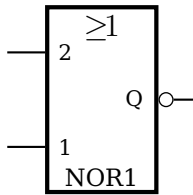
Not Or

```

1 \begin{pspicture}(-0.5,0)(3,3)
2 \logic[logicType=nor,
3   logicShowNode]{NOR1}
4 \end{pspicture}

```

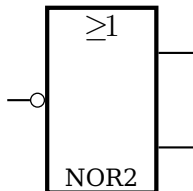

```

1 \begin{pspicture}(-0.5,0)(3,3)
2 \logic[logicType=nor,
3   logicChangeLR]{NOR2}
4 \end{pspicture}

```

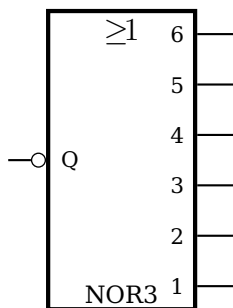

```

1 \begin{pspicture}(4,5)
2 \logic[logicType=nor,
3   logicShowNode,
4   logicWidth=2,
5   logicHeight=4,
6   logicNInput=6,
7   logicChangeLR](1,1){NOR3}
8 \end{pspicture}

```

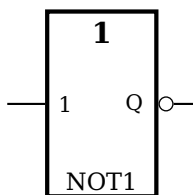
Not

```

1 \begin{pspicture}(-0.5,0)(3,3)
2 \logic[logicType=not,
3   logicShowNode]{NOT1}
4 \end{pspicture}

```

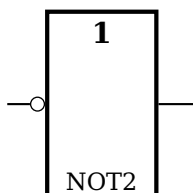

```

1 \begin{pspicture}(-0.5,0)(3,3)
2 \logic[logicType=not,
3   logicChangeLR]{NOT2}
4 \end{pspicture}

```

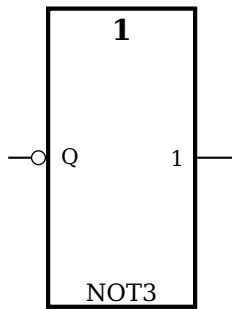

```

1 \begin{pspicture}(4,5)
2 \logic[logicType=not,
3   logicShowNode,
4   logicWidth=2,
5   logicHeight=4,
6   logicChangeLR](1,1){NOT3}
7 \end{pspicture}

```

Exclusive OR

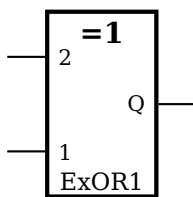

```

1 \begin{pspicture}(-0.5,0)(3,3)
2 \logic[logicType=exor,
3   logicShowNode]{ExOR1}
4 \end{pspicture}

```

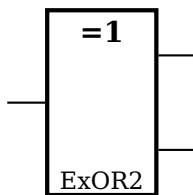

```

1 \begin{pspicture}(-0.5,0)(3,3)
2 \logic[logicType=exor,
3   logicChangeLR]{ExOR2}
4 \end{pspicture}

```

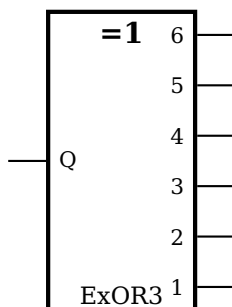

```

1 \begin{pspicture}(4,5)
2 \logic[logicType=exor,
3   logicShowNode,
4   logicNInput=6,
5   logicWidth=2,
6   logicHeight=4,
7   logicChangeLR](1,1){ExOR3}
8 \end{pspicture}

```

Exclusive NOR

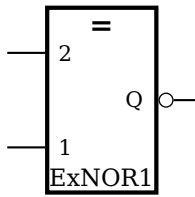

```

1 \begin{pspicture}(-0.5,0)(3,3)
2 \logic[logicType=exnor,
3   logicShowNode]{ExNOR1}
4 \end{pspicture}

```

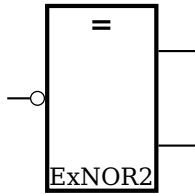

```

1 \begin{pspicture}(-0.5,0)(3,3)
2 \logic[logicType=exnor,
3   logicChangeLR]{ExNOR2}
4 \end{pspicture}

```

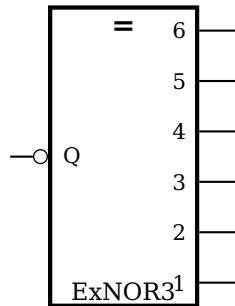

```

1 \begin{pspicture}(4,5)
2 \logic[logicType=exnor,
3   logicShowNode,
4   logicNInput=6,
5   logicWidth=2,
6   logicHeight=4,
7   logicChangeLR](1,1){ExNOR3}
8 \end{pspicture}

```

3.3 RS Flip Flop

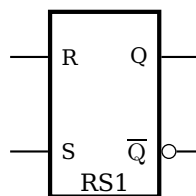

```

1 \begin{pspicture}(-1,-1)(3,3)
2 \logic[logicShowNode,
3   logicType=RS]{RS1}
4 \end{pspicture}

```

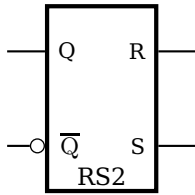

```

1 \begin{pspicture}(-1,-1)(3,3)
2 \logic[logicShowNode,
3   logicType=RS,
4   logicChangeLR]{RS2}
5 \end{pspicture}

```

3.4 D Flip Flop

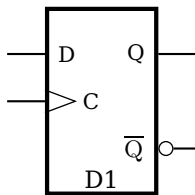

```

1 \begin{pspicture}(-1,-1)(3,3)
2 \logic[logicShowNode,
3   logicType=D]{D1}
4 \end{pspicture}

```

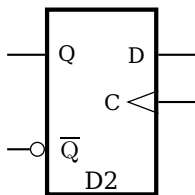

```

1 \begin{pspicture}(-1,-1)(3,3)
2 \logic[logicShowNode=true,
3   logicType=D,
4   logicChangeLR]{D2}
5 \end{pspicture}

```

3.5 JK Flip Flop

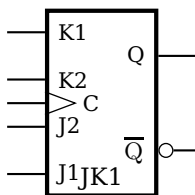

```

1 \begin{pspicture}(-1,-1)(3,3)
2 \logic[logicShowNode,
3   logicType=JK,
4   logicKInput=2,
5   logicJInput=2]{JK1}
6 \end{pspicture}

```

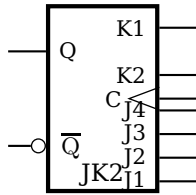

```

1 \begin{pspicture}(-1,-1)(3,3)
2 \logic[logicShowNode,logicType=JK,
3   logicKInput=2, logicJInput=4,
4   logicChangeLR]{JK2}
5 \end{pspicture}

```

3.6 Other Options

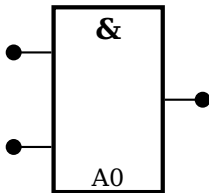

```

1 \begin{pspicture}(-0.5,0)(3,2.5)
2 \logic[logicShowDot]{A0}
3 \end{pspicture}

```

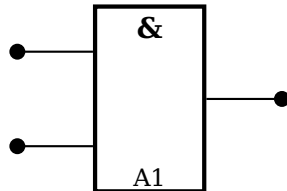

```

1 \begin{pspicture}(-1,0)(3,2.5)
2 \logic[logicWireLength=1,
3   logicShowDot]{A1}
4 \end{pspicture}

```

The unit of `logicWireLength` is the same than the actual one for `pstricks`, set by the `unit` option.

3.7 The Node Names

Every logic circuit is defined with its name, which should be a unique one. If we have the following NAND circuit, then `pst-circ` defines the nodes

```
NAND11, NAND12, NAND13, NAND14, NAND1Q
```

If there exists an inverted output, like for all the Flip Flops, then the negated one gets the appendix `neg` to the node name. For example:

```
NAND1Q, NAND1Qneg
```

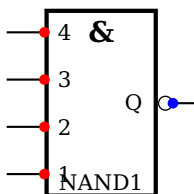

```

1 \begin{pspicture}(-0.5,0)(2.5,3)
2 \logic[logicShowNode=true,%
3   logicLabelstyle=\footnotesize,%
4   logicType=nand,%
5   logicNInput=4]{NAND1}
6 \multido{\n=1+1}{4}{%
7   \pscircle*[linecolor=red](NAND1\n){2pt}%
8 }
9 \pscircle*[linecolor=blue](NAND1Q){2pt}
10 \end{pspicture}

```

Now it is possible to draw a line from the output to the input

```
\ncbar[angleA=0,angleB=180]{<Node A>}{<Node B>}
```

It may be easier to print a grid since the drawing phase and then comment it out if all is finished.

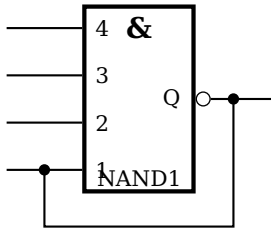

```

1 \begin{pspicture}(-1,-1)(2.5,3)
2 \logic[logicShowNode=true,%
3   logicLabelstyle=\footnotesize,%
4   logicType=nand,%
5   logicWireLength=1,%
6   logicNInput=4]{NAND1}
7 \pnode(-0.5,0|NAND11){tempA}
8 \pnode(2,0|NAND1Q){tempB}
9 \end{pspicture}
10 \ncbar[angleA=-90,angleB=0,arm=0.75,%
11   arrows=**,dotsize=0.15]{tempA}{tempB}

```

3.8 Examples

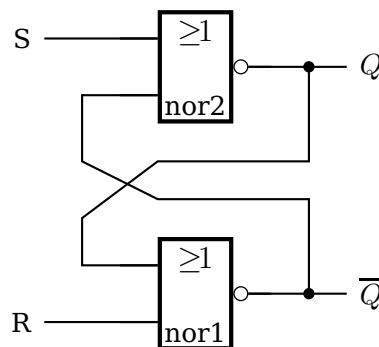

```

1 \begin{pspicture}(-1,0)(5,5)
2 \psset{logicType=nor,logicLabelstyle=\normalsize,%
3   logicWidth=1,logicHeight=1.5,dotsize=0.15}
4 \logic(1.5,0){nor1}
5 \logic(1.5,3){nor2}
6 \psline(nor2Q)(4,0|nor2Q)
7 \uput[0](4,0|nor2Q){$Q$}
8 \psline(nor1Q)(4,0|nor1Q)
9 \uput[0](4,0|nor1Q){$\overline{Q}$}
10 \psline{*-}(3.50,0|nor2Q)(3.5,2.5)(1.5,2.5)
11   (0.5,1.75)(0.5,0|nor12)(nor12)
12 \psline{*-}(3.50,0|nor1Q)(3.5,2)(1.5,2)
13   (0.5,2.5)(0.5,0|nor21)(nor21)
14 \psline(0,0|nor11)(nor11)\uput[180](0,0|nor11){R}
15 \psline(0,0|nor22)(nor22)\uput[180](0,0|nor22){S}
16 \end{pspicture}

```

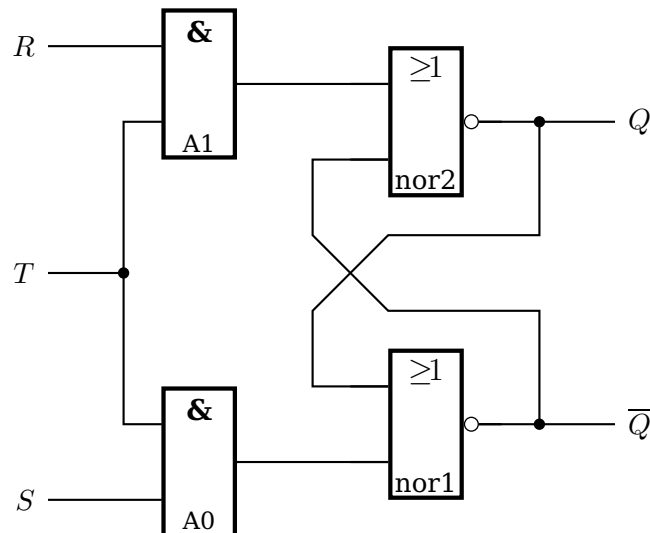

```

1 \begin{pspicture}(-4,0)(5,7)
2   \psset{logicWidth=1, logicHeight=2, dotsize=0.15}
3   \logic[logicWireLength=0](-2,0){A0}
4   \logic[logicWireLength=0](-2,5){A1}
5   \ncbar[angleA=-180,angleB=-180,arm=0.5]{A11}{A02}
6   \psline[dotsize=0.15]{-*}(-3.5,3.5)(-2.5,3.5)
7   \uput[180](-3.5,3.5){T}
8   \psline(-3.5,0.5)(A01)\uput[180](-3.5,0.5){S}
9   \psline(-3.5,6.5)(A12)\uput[180](-3.5,6.5){R}
10  \psset{logicType=nor, logicLabelstyle=\normalsize}
11  \logic(1,0.5){nor1}
12  \logic(1,4.5){nor2}
13  \psline(nor2Q)(4,0|nor2Q)
14  \uput[0](4,0|nor2Q){Q}
15  \psline(nor1Q)(4,0|nor1Q)
16  \uput[0](4,0|nor1Q){\overline{Q}}
17  \psline{*-}(3,0|nor2Q)(3,4)(1,4)(0,3)(0,0|nor12)(nor12)
18  \psline{*-}(3,0|nor1Q)(3,3)(1,3)(0,4)(0,0|nor21)(nor21)
19  \psline(A0Q)(nor11)
20  \psline(A1Q)(nor22)
21 \end{pspicture}

```

4 Adding new components

Adding new components is not simple. As a matter of fact, because of the complex mechanism of `\multidipole`, there are multiple steps. Nevertheless, it can take some time...

If you want to modify the code, you need to know the following things. For a dipole, you first need to define the following items:

```

1 \def\component_name{\@ifnextchar[{\pst@component_name}{\pst@component_name[]}}
2 %
3 \def\pst@component/_name[#1](#2)(#3)#4{#{%
4   \pst@draw@dipole{#1}{#2}{#3}{#4}\pst@draw@component_name
5   }\ignorespaces}
6 %

```

```

7 \def\pst@multidipole@component_name{\@ifnextchar[{\pst@multidipole@component_name@}
8 %
9 {\pst@multidipole@component_name@[]}}
10 %
11 \def\pst@multidipole@component_name@[#1]#2{%
12 \expandafter\def\csname pst@circ@tmp@\number\pst@circ@count@iii\endcsname{#2}%
13 {\psset{#1}%
14 \ifPst@circ@parallel\aftergroup\advance\aftergroup\pst@circ@count@i\aftergroup\
15 m@ne\fi}%
16 \pst@circ@count@ii=\pst@circ@count@i
17 \advance\pst@circ@count@ii\@ne%
18 \toks0\expandafter{\pst@multidipole@output}%
19 \edef\pst@multidipole@output{%
20 \the\toks0%
21 \pst@multidipole@def@coor%
22 \noexpand\component_name[#1]%
23 (! X@the\pst@circ@count@i\space Y@the\pst@circ@count@i)%
24 (! X@the\pst@circ@count@ii\space Y@the\pst@circ@count@ii)%
25 {\noexpand\csname pst@circ@tmp@\number\pst@circ@count@iii\endcsname}%
26 }%
27 \pst@multidipole@
28 }
29 %
30 \def\pst@draw@component_name{%
31 % The PSTricks code for your component
32 % The center of the component is at (0,0)
33 \node(component_left_end,0){dipole@1}
34 \node(component_right_end,0){dipole@2}}

```

Then, you have to make some changes in the `\multidipole` core code...In the definition of `\pst@multidipole`, look for the last `\ifx` test

```

1 % ...
2 % Extract from \pst@multidipole
3 \else\ifx\circledipole#4\let\next\pst@multidipole@circledipole
4 \else\ifx\LED #4\let\next\pst@multidipole@LED
5 \else % Put your modification here
6 \let\next\ignorespaces
7 \fi\fi\fi
8 % Extract form \pst@multidipole
9 % ...

```

and add (marked with `%%%`)

```

1 % ...
2 % Extract from \pst@multidipole
3 \else\ifx\circledipole #4\let\next\pst@multidipole@circledipole
4 \else\ifx\LED #4\let\next\pst@multidipole@LED
5 \else\ifx\component_name#4\let\next\pst@multidipole@component_name%%
6 \else\let\next\ignorespaces
7 \fi\fi\fi\fi
8 % Extract form \pst@multidipole
9 % ...

```

Do the same in `\pst@multidipole@`

```

1 % ...
2 % Extract from \pst@multidipole@

```

```
3 \else\ifx\circledipole#1\let\next\pst@multidipole@circledipole
4 \else\ifx\LED #1\let\next\pst@multidipole@LED
5 \else\ifx\component_name#1\let\next\pst@multidipole@component_name%%
6 \else\let\next\ignorespaces\pst@multidipole@output
7 \fi\fi\fi\fi
8 % Extract form \pst@multidipole@
9 % ...
```

and that's it! All you have to do then is send your modified `pst-circ.tex` to me and it will become part of the official release of `pst-circ`.

5 List of all optional arguments for pst-circ

Note: the default for booleans is always false.

Key	Type	Default
intensity	boolean	true
intensitylabel	ordinary	
intensitylabelcolor	ordinary	black
intensitylabeloffset	ordinary	0.5
intensitycolor	ordinary	black
intensitywidth	ordinary	\pslinewidth
tension	boolean	true
tensionlabel	ordinary	
tensionlabelcolor	ordinary	black
tensionoffset	ordinary	1
tensionlabeloffset	ordinary	1.2
tensioncolor	ordinary	black
tensionwidth	ordinary	\pslinewidth
labeloffset	ordinary	0.7
labelangle	ordinary	0
labelInside	ordinary	0
dipoleconvention	ordinary	receptor
directconvention	boolean	true
dipolestyle	ordinary	normal
parallel	ordinary	true
parallelarm	ordinary	1.5
parallelsep	ordinary	0
parallelnode	ordinary	true
intersect	boolean	true
intersectA	ordinary	[none]
intersectB	ordinary	[none]
OAperfect	boolean	true
OApower	boolean	true
OAINvert	boolean	true
OAIplus	boolean	true
OAIMinus	boolean	true
OAIout	boolean	true
OAIpluslabel	ordinary	
OAIMinuslabel	ordinary	
OAIoutlabel	ordinary	
transistorcircle	boolean	true
transistorinvert	boolean	true
transistoribase	boolean	true
transistoricollector	boolean	true
transistoriemitter	boolean	true
transistoribaselabel	ordinary	

Continued on next page

Continued from previous page

Key	Type	Default
transistorcollectorlabel	ordinary	
transistoriemitterlabel	ordinary	
FETchanneltype	ordinary	[none]
FETmemory	boolean	true
transistorotype	ordinary	NPN
basesep	ordinary	0
TRot	ordinary	0
circedge	ordinary	\pcangle
primarylabel	ordinary	
secondarylabel	ordinary	
transformerprimary	ordinary	true
transformerisecondary	ordinary	true
transformerprimarylabel	ordinary	
transformerisecondarylabel	ordinary	
tripolestyle	ordinary	normal
variable	boolean	true
logicChangeLR	boolean	true
logicShowDot	boolean	true
logicShowNode	boolean	true
logicWidth	ordinary	1.5
logicHeight	ordinary	2.5
logicType	ordinary	and
logicNInput	ordinary	2
logicJInput	ordinary	2
logicKInput	ordinary	2
logicWireLength	ordinary	0.5
logicLabelstyle	ordinary	\small
logicSymbolstyle	ordinary	\large
logicSymbolpos	ordinary	0.5
logicNodestyle	ordinary	\footnotesize
inputarrow	boolean	true
programmable	boolean	true
connectingdot	boolean	true
groundstyle	ordinary	ads
antennastyle	ordinary	two
output	ordinary	top
L0style	ordinary	
dipoleinput	ordinary	left
value	ordinary	0
tripoleinput	ordinary	left
tripoleconfig	ordinary	left
couplerstyle	ordinary	hxbrid
quadripoleinput	ordinary	left

References

- [1] Michel Goossens, Frank Mittelbach, Sebastian Rahtz, Denis Roegel, and Herbert Voß. *The L^AT_EX Graphics Companion*. Addison-Wesley Publishing Company, Reading, Mass., 2nd edition, 2007.
- [2] Laura E. Jackson and Herbert Voß. Die Plot-Funktionen von `pst-plot`. *Die T_EXnische Komödie*, 2/02:27–34, June 2002.
- [3] Nikolai G. Kollock. *PostScript richtig eingesetzt: vom Konzept zum praktischen Einsatz*. IWT, Vaterstetten, 1989.
- [4] Herbert Voß. Die mathematischen Funktionen von Postscript. *Die T_EXnische Komödie*, 1/02:40–47, March 2002.
- [5] Herbert Voss. *PSTricks Support for pdf*. <http://PSTricks.de/pdf/pdfoutput.phtml>, 2002.
- [6] Herbert Voß. *PSTricks – Grafik für T_EX und L^AT_EX*. DANTE/Lehmanns Media, Heidelberg/Berlin, 5. edition, 2008.
- [7] Herbert Voß. *Mathematik mit L^AT_EX*. DANTE/Lehmanns Media, Heidelberg/Berlin, 2009.
- [8] Michael Wiedmann and Peter Karp. *References for T_EX and Friends*. <http://www.miwie.org/tex-refs/>, 2003.
- [9] Timothy Van Zandt. *PSTricks - PostScript macros for Generic TeX*. <http://www.tug.org/application/PSTricks>, 1993.

Index

- :U, 9, 16, 17
- ads, 30
- and, 39, 40
- antennastyle, 31
- arrows, 10
- arrows, 6

- bandpass, 32
- basesep, 6, 7, 11
- \battery, 4, 16
- bottom, 31, 35

- \caoacitor, 8
- \capacitor, 4, 14–16
- chemical, 14
- \circledipole, 5
- circulator, 35
- \coil, 4, 15, 16
- Collector, 7
- couplerstyle, 36
- crystal, 15, 31
- curved, 15

- D, 45
- \diode, 5, 8, 15
- dipoleconvention, 10, 11
- dipoleinput, 32–34
- dipolestyle, 14–16, 32, 33
- directconvention, 10, 11
- directional, 36
- divider, 33

- elektor, 14–16
- elektorchemical, 15
- elektorcurved, 15
- Emitter, 7
- exnor, 44
- exor, 43, 44

- FET, 18, 19
- FETchannel, 19
- FETmemory, 19
- File
 - pst-circ.tex, 50
- \filter, 32

- french, 17

- generator, 10, 11
- \ground, 9
- groundstyle, 30
- GT0, 15

- highpass, 32
- hybrid, 36

- \ICC, 14
- \Icc, 4
- \ifx, 49
- inputarrow, 31–36
- intensity, 10, 11
- intensitycolor, 11
- intensitylabel, 11
- intensitylabelcolor, 11
- intensitylabeloffset, 11
- intensitywidth, 11
- isolator, 35

- JK, 45

- Keyvalue
 - ads, 30
 - and, 39
 - bandpass, 32
 - bottom, 31, 35
 - circulator, 35
 - crystal, 31
 - directional, 36
 - divider, 33
 - generator, 10
 - highpass, 32
 - hybrid, 36
 - isolator, 35
 - left, 31–36
 - lowpass, 32
 - multiplier, 33
 - N, 33
 - old, 30
 - receptor, 10
 - right, 31–36
 - three, 31

- top, 31, 35
- triangle, 30, 31
- two, 31
- Keyword
 - antennastyle, 31
 - arrows, 6
 - basesep, 6, 7, 11
 - couplerstyle, 36
 - dipoleconvention, 10, 11
 - dipoleinput, 32–34
 - dipolestyle, 14–16, 32, 33
 - directconvention, 10, 11
 - FETchannel, 19
 - FETmemory, 19
 - groundstyle, 30
 - inputarrow, 31–36
 - intensity, 10, 11
 - intensitycolor, 11
 - intensitylabel, 11
 - intensitylabelcolor, 11
 - intensitylabeloffset, 11
 - intensitywidth, 11
 - labelangle, 9, 16, 17
 - labelInside, 10
 - labeloffset, 5, 9, 17, 18
 - logicChangeLR, 39–45
 - logicHeight, 39–44
 - logicJInput, 39, 45
 - logicKInput, 39, 45
 - logicLabelstyle, 39
 - logicNInput, 39–44
 - logicNodestyle, 39
 - logicShowDot, 39, 46
 - logicShowNode, 39–45
 - logicSymbolpos, 39
 - logicSymbolstyle, 39
 - logicType, 39–45
 - logicWidth, 39–44
 - logicWireLength, 39, 46
 - LOstyle, 31
 - nodesep, 7
 - OAminuslabel, 11
 - OAINvert, 18
 - OAIoutlabel, 11
 - OAIpluslabel, 11
 - OApertect, 18
 - OApower, 6
 - output, 31
 - parallel, 12, 13
 - primarylabel, 10
 - programmable, 33
 - quadrupoleinput, 36
 - secondarylabel, 10
 - tension, 10, 11
 - tensioncolor, 11
 - tensionlabel, 11
 - tensionlabelcolor, 11
 - tensionlabeloffset, 11
 - tensionoffset, 11
 - tensionwidth, 11
 - transformerprimarylabel, 12
 - transformersecondarylabel, 12
 - transistoribaselabel, 11
 - transistoricollectorlabel, 11
 - transistoriemitter, 7
 - transistoriemitterlabel, 11
 - transistorinvert, 7
 - transistoritype, 6, 7, 18, 19
 - tripoleconfig, 35
 - tripoleinput, 35, 36
 - tripolestyle, 17, 35
 - unit, 46
 - value, 33
 - variable, 16
 - zigzag, 16
- labelangle, 9, 16, 17
- labelInside, 10
- labeloffset, 5, 9, 17, 18
- \lamp, 5
- \LED, 5
- left, 17, 31–36
- \logic, 39
- logicChangeLR, 39–45
- logicHeight, 39–44
- logicJInput, 39, 45
- logicKInput, 39, 45
- logicLabelstyle, 39
- logicNInput, 39–44
- logicNodestyle, 39
- logicShowDot, 39, 46
- logicShowNode, 39–45
- logicSymbolpos, 39
- logicSymbolstyle, 39

- logicType, 39–45
- logicWidth, 39–44
- logicWireLength, 39, 46
- L0style, 31
- lowpass, 32
- Macro
 - \battery, 4, 16
 - \caoacitor, 8
 - \capacitor, 4, 14–16
 - \circledipole, 5
 - \coil, 4, 15, 16
 - \diode, 5, 8, 15
 - \filter, 32
 - \ground, 9
 - \ICC, 14
 - \Icc, 4
 - \ifx, 49
 - \lamp, 5
 - \LED, 5
 - \logic, 39
 - \multidipole, 8, 13, 30, 48, 49
 - \ncangle, 6
 - \OA, 6, 17, 18
 - \optoCoupler, 8
 - \pcline, 30
 - \potentiometer, 7, 16–18
 - \resistor, 4, 8, 14, 16
 - \resitor, 9
 - \RFLine, 4
 - \switch, 5
 - \tension, 9
 - \transformer, 8, 10, 16
 - \transistor, 6, 18, 19
 - \Tswitch, 7, 17
 - \Ucc, 4
 - \wire, 9
 - \Zener, 5
- \multidipole, 8, 13, 30, 48, 49
- multido, 3
- multiplier, 33
- N, 33
- nand, 41
- \ncangle, 6
- nodesep, 7
- nor, 42
- not, 42
- \OA, 6, 17, 18
- OAminuslabel, 11
- OAINvert, 18
- OAIoutlabel, 11
- OAIpluslabel, 11
- OApertect, 18
- OApower, 6
- old, 30
- \optoCoupler, 8
- or, 41
- output, 31
- P, 19
- Package
 - multido, 3
 - pst-circ, 3, 6, 46, 50
 - pst-node, 3
 - pst-xkey, 3
 - pstricks, 3
- parallel, 12, 13
- \pcline, 30
- PNP, 6, 7
- \potentiometer, 7, 16–18
- primarylabel, 10
- programmable, 33
- pst-circ, 3, 6, 46, 50
- pst-circ.tex, 50
- pst-node, 3
- pst-xkey, 3
- pstricks, 3
- quadripoleinput, 36
- quadrupole, 11
- receptor, 10
- rectangle, 15, 16
- \resistor, 4, 8, 14, 16
- \resitor, 9
- \RFLine, 4
- right, 17, 31–36
- RS, 44
- secondarylabel, 10
- \switch, 5
- Syntax
 - Collector, 7

- Emitter, 7
- \backslash tension, 9
- tension, 10, 11
- tensioncolor, 11
- tensionlabel, 11
- tensionlabelcolor, 11
- tensionlabeloffset, 11
- tensionoffset, 11
- tensionwidth, 11
- three, 31
- thyristor, 15
- top, 31, 35
- \backslash transformer, 8, 10, 16
- transformerprimarylabel, 12
- transformersecondarylabel, 12
- \backslash transistor, 6, 18, 19
- transistoribaselabel, 11
- transistoricollectorlabel, 11
- transistoriemitter, 7
- transistoriemitterlabel, 11
- transistorinvert, 7
- transistortype, 6, 7, 18, 19
- triac, 15
- triangle, 30, 31
- tripole, 6, 11
- tripoleconfig, 35
- tripoleinput, 35, 36
- tripolestyle, 17, 35
- \backslash Tswitch, 7, 17
- two, 31
- twoCircles, 14

- \backslash Ucc, 4
- unit, 46

- Value
 - :U, 9, 16, 17
 - and, 40
 - chemical, 14
 - crystal, 15
 - curved, 15
 - D, 45
 - elektor, 14–16
 - elektorchemical, 15
 - elektorcurved, 15
 - exnor, 44
 - exor, 43, 44
 - FET, 18, 19
 - french, 17
 - generator, 10, 11
 - GTO, 15
 - highpass, 32
 - JK, 45
 - left, 17
 - nand, 41
 - nor, 42
 - not, 42
 - or, 41
 - P, 19
 - PNP, 6, 7
 - rectangle, 15, 16
 - right, 17
 - RS, 44
 - thyristor, 15
 - triac, 15
 - twoCircles, 14
 - varistor, 14
 - zigzag, 14, 16
- value, 33
- variable, 16
- varistor, 14

- \backslash wire, 9

- \backslash Zener, 5
- zigzag, 14, 16